

# RG-PBOX

**V1.06**

**2022-01-10**

copyright © 2022

copyright © 2022



- 
- 
- 

- 
- 
- 
- 
- 
- 

<http://www.ruijie.com.cn>

<http://www.ruijie.com.cn/fw/>

7\*24h

<http://ocs.ruijie.com.cn>

7\*24h

4008-111-000

<http://www.ruijie.com.cn/special/fw/tool/xryf/>

4008111000@ruijie.com.cn



APP

## 1.

---

 注意、警告、提醒操作中应注意的事项。

 说明、提示、窍门、对操作内容的描述进行必要的补充

对于产品的支持情况进行必要的补充。

---

## 2.



	IEC/EN 61000-4-5 Surge	/	1kV
		/	2kV
		/	6kV
	GB4943-2011		
x x mm	187x89x36.5		
kg	0.6kg		

RG-PBOX-DC12      2    10M/100M/1000M      1

1-1 RG-PBOX-DC12

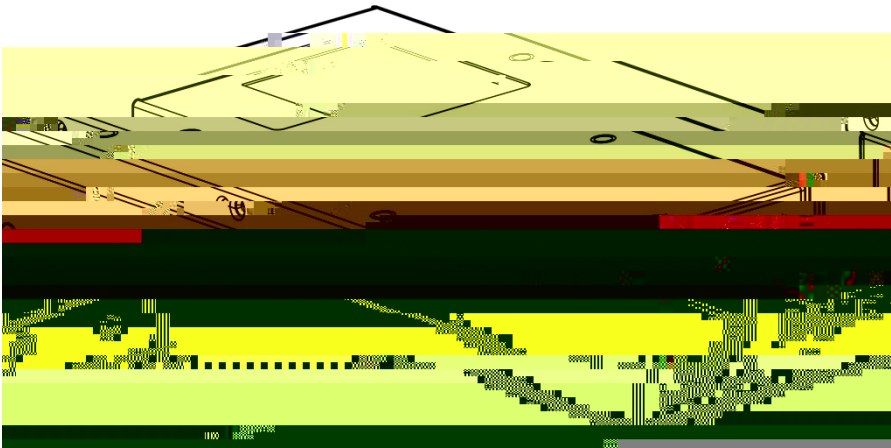

1-2 RG-PBOX-DC12

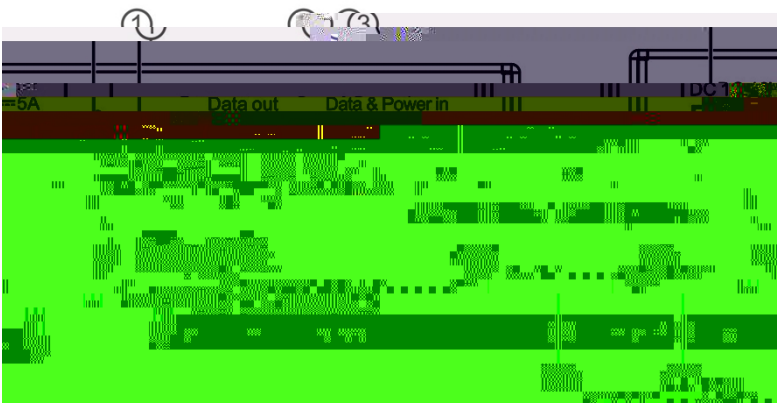

12V		&	PoE
12V			
PoE	OK		

1-3 RG-PBOX-DC12 V1.XX

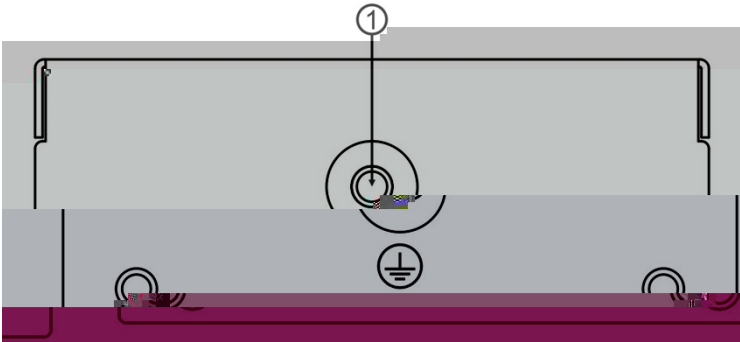

RG-PBOX-DC12

PoE

43-57V DC

12Vdc

5A



60W

RG-PBOX-DC12

10cm

	Power-in		PoE
			PoE OK
	Power-out		12Vdc
			12Vdc

## 1.2 RG-PBOX-AC24

	RG-PBOX-AC24	
	<p>43-57V DC</p> <p>24Vac</p> <p>2.5A</p> <p>60W</p> <hr/> <p> 注：最大输出功率取决于输入功率，例如：90W PoE 端口输入时，最大输出功率为60W；60W PoE 端口输入时，最大输出额定功率为40W。</p> <p> PoE 端口供电线序为 1236 和 4578</p> <hr/>	
	12.5W	
	-20°C ~50°C	
	-40°C ~ 70°C	
	10% ~ 90% RH( )	
	10% ~ 90% RH( )	
	IP40	
EMI	GB 9254 2008,FCC Part 15, CISPR (EN55022) class A,	
EMS	IEC/EN 61000-4-2 ESD	
	8KV	
	15KV	
	IEC/EN 61000-4-4 EFT	
	1kV	
	IEC/EN 61000-4-5 Surge	
	/	1kV
	/	2kV
	/	6kV
	GB4943-2011	
× × mm	187x89x36.5	
kg	0.72kg	

RG-PBOX-AC24            2    10M/100M/1000M            1

1-4 RG-PBOX-AC24

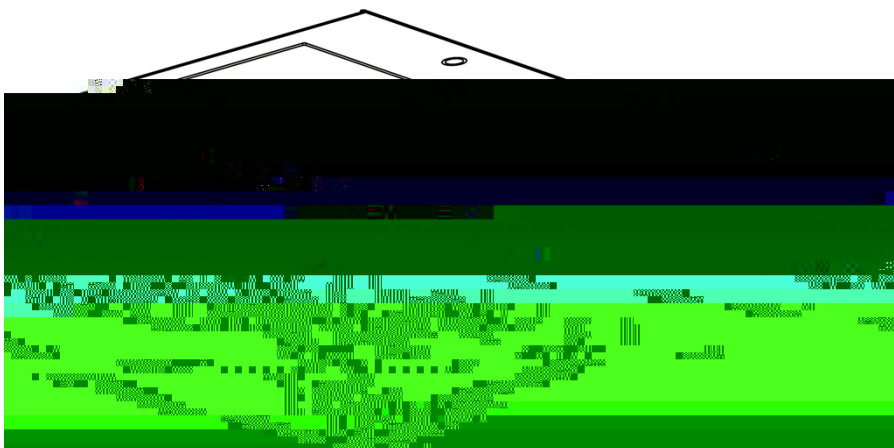

1-5 RG-PBOX-AC24

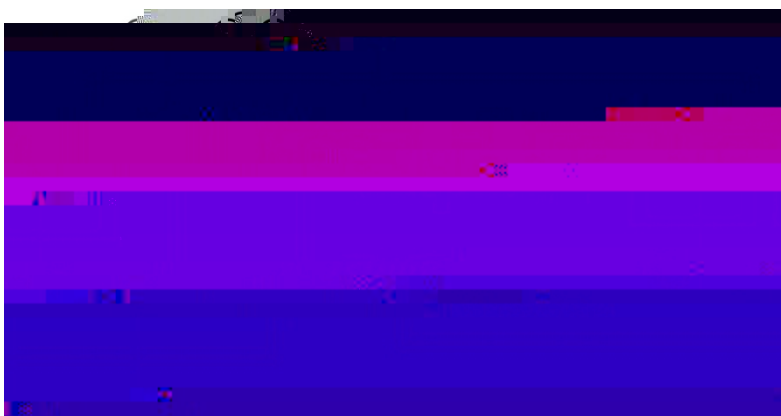

24Vac		&	PoE
24Vac			
PoE	OK		

1-6 RG-PBOX-AC24

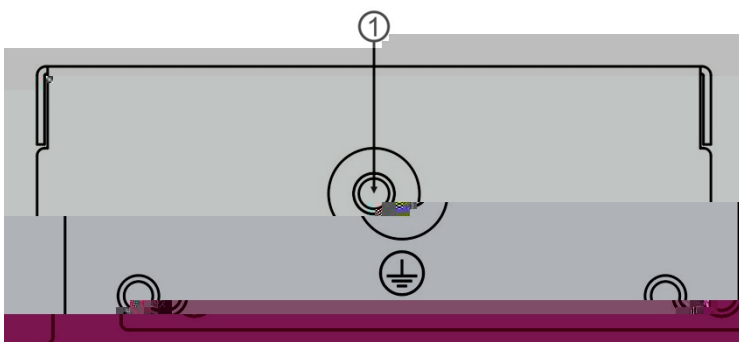

RG-PBOX-AC24

PoE

43-57V DC

24Vac

2.5A

60W

RG-PBOX-AC24

10cm

	Power-in		PoE
			PoE OK
	Power-out		24Vac
			24Vac

## 2

### 2.1

#### RG-PBOX

---



以下的安全建议并不涉及所有可能出现的危险情况。

---

#### 2.1.1

- 
- 
- 
- 
- 
- 

5000m

5000m

5000m

#### 2.1.2

- 
- 
- 

#### 2.1.3

- 
- 
- 
- 
- 
-

## 2.1.4

RG-PBOX

RG-PBOX

- 
- 
- 
- 

## 2.2

RG-PBOX

### 2.2.1

RG-PBOX

10cm

- 
- 
- 

RG-PBOX

-20°C ~ 50°C	10%-90%( )



设备工作环境温、湿度的测量点，指在设备前后没有保护板时测量。距地板 1.5m 高度，并距设备前面板 0.4m 处的测量数值。

---

### 2.2.2

0.5μ m	/ m <sup>3</sup>	3.5× 10 <sup>6</sup>
5μ m	/ m <sup>3</sup>	3× 10 <sup>4</sup>

	(mg/m <sup>3</sup> )	(mg/m <sup>3</sup> )
SO <sub>2</sub>	0.3	1.0
H <sub>2</sub> S	0.1	0.5
NO <sub>2</sub>	0.5	1.0
Cl <sub>2</sub>	0.1	0.3

 平均值是一周内的平均值。最大值是在一周内的极限值，每天不超过 30 分钟。

### 2.2.3

RG-PBOX

- 
- 

### 2.2.4

RG-PBOX

 PBOX 接地线的正常连接是 PBOX 防雷、防干扰的重要保障，所以用户必须正确接地。

### 2.2.5

1Ω RG-PBOX 1

2-1 RG-PBOX

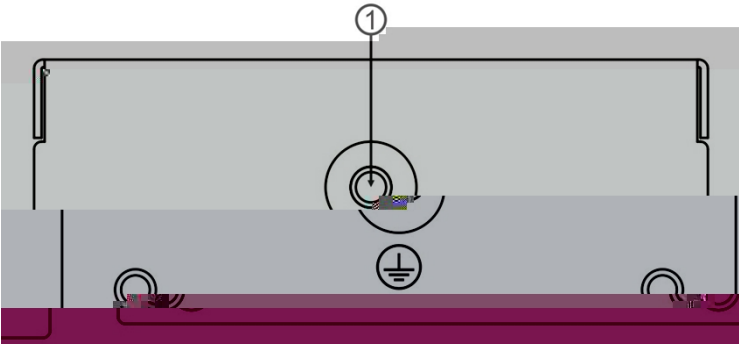

### 2.2.6 EMI

- 
- 
- 
- 

### 2.3

- 



---

 RG-PBOX 系列电源适配器不附带工具包，工具需要用户自己准备。

---

### 3

---

 请确认您已经仔细阅读第二章的内容，确认第二章所述的要求已经满足。

---

#### 3.1

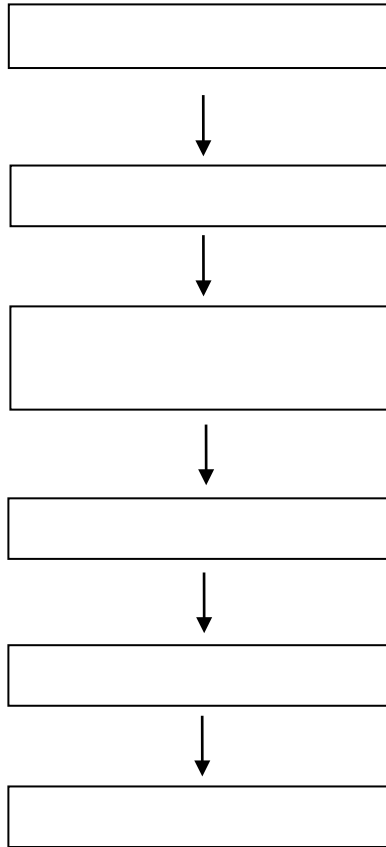

#### 3.2

- 
- 
- 
-

### 3.3 RG-PBOX

- :
- 
- PBOX PoE 4 PBOX , 5
- PBOX
- IP IP
- 
- 
- 10
- RG-PBOX

#### 3.3.1 RG-PBOX-DC12&RG-PBOX-AC24

1 M4\*10

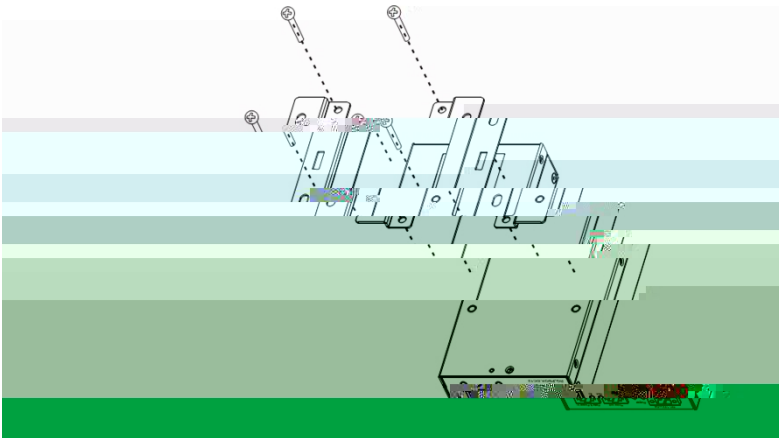

2 M4\*20

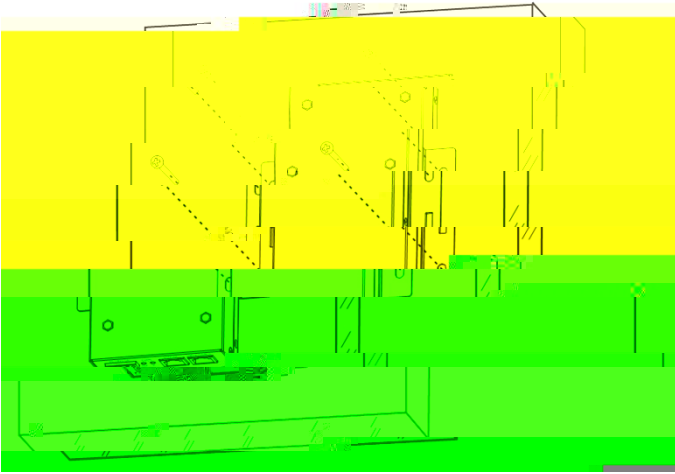

3

1

RG-PBOX

" Data Out"

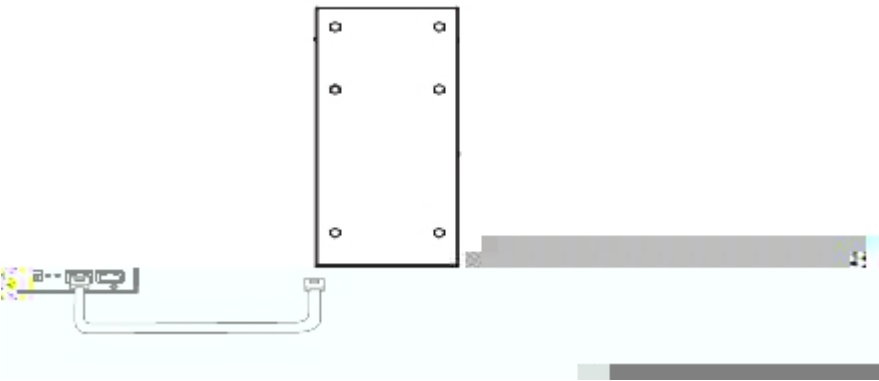

4

5m  
RG-PBOX-DC12

18AWG

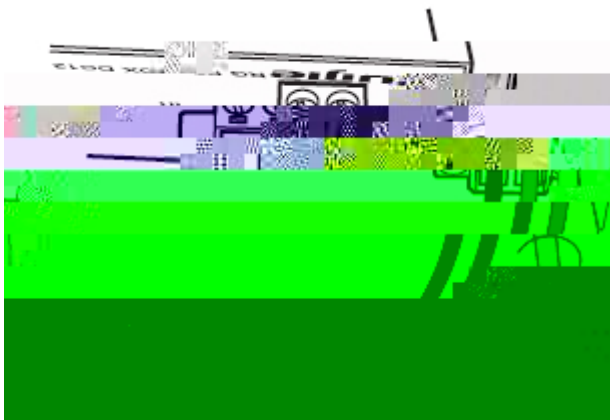
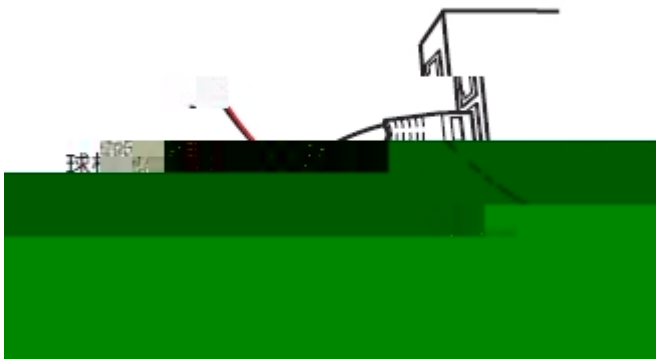

5

2

HPoE

" Data&Power in"

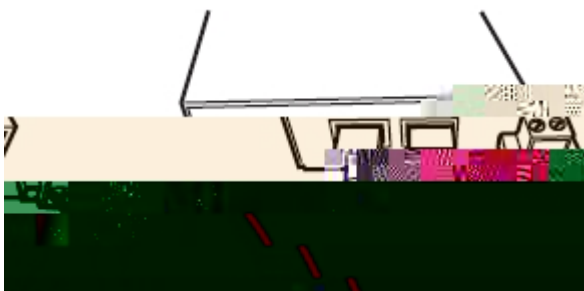

6



7

RG-PBOX

### 3.3.2 RG-PBOX-DC12&RG-PBOX-AC24

1

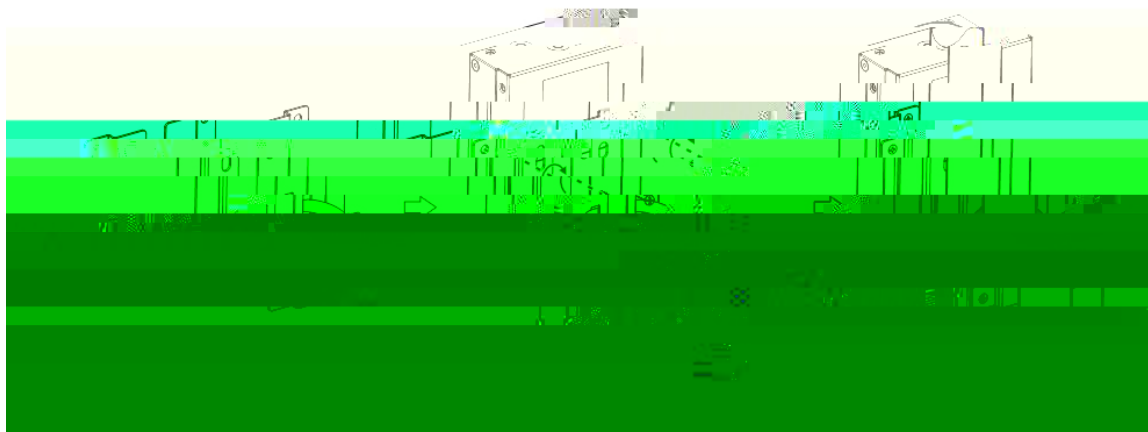

2

3 -7

### 3.4

---

 检查安装是否正确之前，请一定确定关闭电源，以免连接错误造成人体伤害和损坏产品部件！

---

- 
- 
-

### 3.5

1.

2.

3.

4.

PBOX

5. PBOX

6. PBOX

# 4

## 4.1

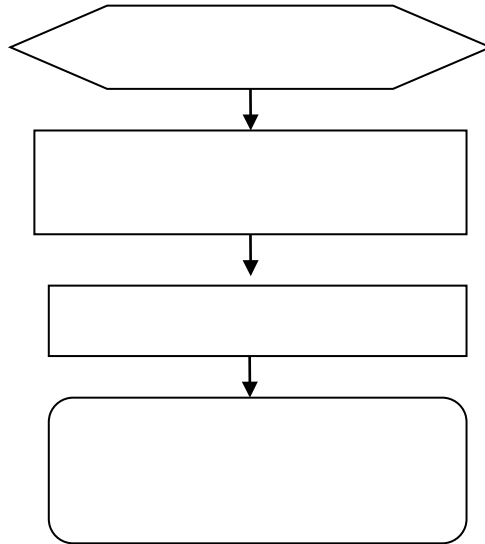

## 4.2

Power-in/out	1 2	
Power-in Power-out		
Power-in Power-out	PBOX	PBOX
Power-in/out ping	" data out"	" data out"

# A

## 1000BASE-T/100BASE-TX/10BASE-T

1000BASE-T/100BASE-TX/10BASE-T

MDI/MDIX Crossover

1000BASE-T	IEEE 802.3ab STP	100	100-ohm 5	5	UTP	STP
1000BASE-T	4		4		1000BASE-T	

A-1 1000BASE-T

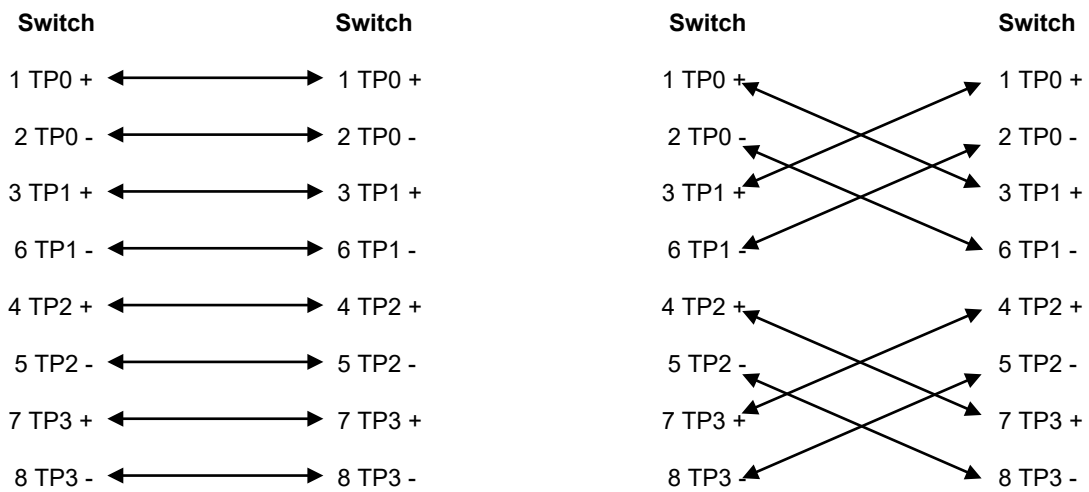

100BASE-TX/10BASE-T

100-ohm 5 100

10Mbps 100-ohm 3,4,5

100BASE-TX/10BASE-T

100Mbps

A-2

A-2 100BASE-TX/10BASE-T

Pin		
1	Input Receive Data+	Output Transmit Data+
2	Input Receive Data-	Output Transmit Data-
3	Output Transmit Data+	Input Receive Data+
6	Output Transmit Data-	Input Receive Data-
4 5 7 8	Not Used	Not Used

100BASE-TX/10BASE-T

A-3

A-3 100BASE-TX/10BASE-T

