



**RG-S2600**

**RGOS 10.4(2)**

©2010



---

# RGOS® 10.4(2)

,  
,  
,

**1.**

Courier New

5

**2.**

Arial

```
[]      []  
{x|y|...}  
[x|y|...]  
//
```

---

3.

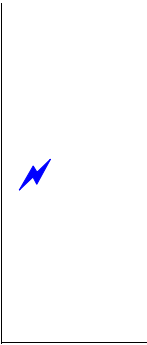

1.

2.

3.



# 1 CLI

## 1.1

### 1.1.1 alias

alias

no

**alias** *mode command-alias original-command*

**no alias** *mode [original-command]*

<i>mode</i>	
<i>command-alias</i>	
<i>original-command</i>	

EXEC

EXEC                                    h p s u un                                    help ping show  
undebug   undebug  
no alias exec

```

Ruijie# s?
*s=show show start-chat start-terminal-service
EXEC
"sv" "show version"
Ruijie# s?
*s=show *sv="show version" show start-chat
start-terminal-service

Ruijie# s?
show start-chat start-terminal-service
"ia"
"ip address"
Ruijie(config-if)# ia ?
A.B.C.D IP address
dhcp IP Address via DHCP
Ruijie(config-if)# ip address
"ip address"

show aliases

```

```

"def-route" "ip route"
0.0.0.0 0.0.0.0 192.168.1.1"
Ruijie# configure terminal
Ruijie(config)# alias config def-route ip route 0.0.0.0 0.0.0.0
192.168.1.1
Ruijie(config)# def-route?
*def-route="ip route 0.0.0.0 0.0.0.0 192.168.1.1"
Ruijie(config)# def-route?
% Unrecognized command.
Ruijie(config)# end
Ruijie# show aliases config
globe configure mode alias:
def-route ip route 0.0.0.0 0.0.0.0 192.168.1.1

```

<b>show aliases</b>	

---

---

---

---

**privilege**

*ommand-string*

*mand-string*

---

---

CLI

0-15

---

---

---

---

CLI

**privilege ?**

---

---

0.0.2 294.68 -139.2 -19.1Hp

```

Ruijie(config)# enable secret level 1 0 test
Ruijie(config)# privilege exec level 1 reload
                1    CLI                reload
Ruijie> reload ?
<cr>
                reload                1                all
Ruijie(config)# privilege exec all level 1 reload
                1    CLI                reload
Ruijie> reload ?
at                reload at a specific time/date
cancel            cancel pending reload scheme
in                reload after a time interval
<cr>

```

<b>enable secret</b>	CLI

## EXEC

```
Ruijie# show aliases exec
```

```
exec mode alias:
```

```
h             help  
p             ping  
s             show  
u             undebug  
un            undebug
```



---

# 2

## 2.1

### 2.1.1 disable

disable

**disable** [*privilege-level*]

	<i>privilege-level</i>	

|

|

|

/ **disable**

|

Ruijie# **disable 10**

	enable	

|

	-	-

## 2.1.2 enable

enable

	-	-

--	--

--	--

--	--

--	--

	-	-

--	--

	-	-

## 2.1.3 enable password

enable password

no

**enable password** [*level level*] {*password* | [0 | 7] *encrypted-password*}**no enable password**

<i>Password</i>	EXEC	
<i>Level</i>		
<b>0 7</b>	0	7
<i>encrypted-password</i>		

> 1 26

>

 EXEC

pw10

Ruijie(config)# **enable password** pw10

<b>enable secret</b>	

-	-

## 2.1.4 enable secret

**enable secret**      **no**

**enable secret** [*level level*] {*secret* | [0 | 5] *encrypted-secret*}

**no enable secret**

<i>Secret</i>	EXEC
<i>Level</i>	
<b>0 5</b>	0      5
<i>encrypted-password</i>	



---

|

|

|

|

**no enable service**

enable service ssh-sesrver, SSH Server

Ruijie(Config # **enable service ssh-sesrver**



---

## **Telnet**

configure terminal

line tty 1 16

---

enable

Web

**no ip http authentication**

Web

local

Ruijie(config)# **ip http authentication local**

**enable service**

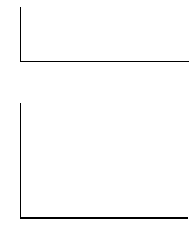

-	-

## 2.1.9 ip telnet source-interface

IP                      Telnet    ip  
**telnet source-interface**

**ip telnet source-interface** *interface-name*

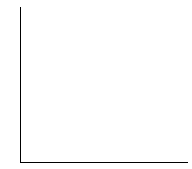

<i>interface-name</i>	IP                      Telnet



IP                      Telnet    telnet  
Telnet  
**no ip telnet source-interface**



Loopback 1                      IP                      Telnet  
Ruijie(config)# **ip telnet source-interface** *Loopback 1*



<b>telnet</b>	Telnet



10.4(2)	

## 2.1.10 lock

---

EXEC

lock

lock

-	-

|

|

|

> lock

>

Locked

>

line

lockable

line

|

Ruijie(config-line)# lockable

Ruijie(config-line)# end

Ruijie# lock

Password: <password>

Again: <password>

Locked

Password: <password>

|

lockable	

|

|

-	-

## 2.1.11 lockable

**lock**            **lock**            **no**            **line**            **lockable**  
**lockable**  
**no lockable**

-	-

┌

┌

line

┌

**lock**

EXEC

┌

```

Ruijie(config)# line console 0
Ruijie(config-line)# lockable
Ruijie(config-line)# end
Ruijie# lock
Password: <password>
Again: <password>
Locked
Password: <password>

```

┌

<b>lock</b>	

---

**login**

**no login**

	-	-

|

|

line

|

AAA  
VTY console

---

|

VTY  
Ruijie(config)# **no aaa new-model**  
Ruijie(config)# **line vty 0**  
Ruijie(config-line)# **password 0 normatest**  
Ruijie(config-line)# **login**

|

--	--	--

**password**

line

-

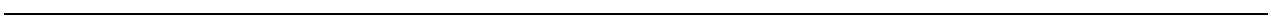

line

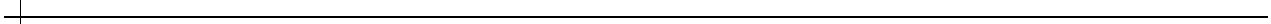
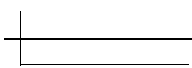

---

username

VTY

Ruijie(config)# **no aaa new-model**

Ruijie(config)# **username test password 0 test**

Ruijie(config)# **line vty 0**

Ruijie(config-line)# **login local**

<b>username</b>	

-	-

## 2.1.15 privilege mode

CLI

-	-

CLI

CLI

CLI

CLI

-	-

--	--

---

	-	-
--	---	---

### 2.1.16 password

line                      line                      **password**                      **no**                      line

**password** {*password* | [0|7] *encrypted-password*}

**no password**

	<i>password</i>	line

---

**service password-encryption**

--	--

<b>interface</b> <i>interface-name</i>	Telnet
<b>!vrf</b> <i>vrf-name</i>	VRF

┌

┌

┌

telnet	
 <b>/ipv6</b>	IPV6

┌

```

1          telnet          IPV4      192.168.1.1
          vlan 1          VRF          vpn1
Ruijie# telnet 192.168.1.1 /source interface vlan 1 /vrf vpn1
2          telnet          IPV6      2AAA:BBBB::CCCC
Ruijie# telnet 2AAA:BBBB::CCCC

```

┌

<b>ip telnet source-interface</b>	IP      Telnet
<b>show session</b>	TTY
<b>exit</b>	

┌

┌

-	-

## 2.1.19 username

---

<i>password</i>	
<b>07</b>	0 7
<i>encrypted-password</i>	
<i>privilege-level</i>	

	<i>message</i>	
	Ruijie(config) Ruijie(config)# <b>banner login</b> \$ <i>enter your password</i> \$	
	-	-
	-	-

### 2.2.2 banner motd

	no banner motd	banner motd
	<b>banner motd</b> <i>c message c</i>	
	<i>c</i>	
	<i>message</i>	

---

```

Ruijie#show boot system
system boot file: flash:/rgos.bin

Ruijie#dir
Directory of flash:/
   11015744 2008-01-01 08:00:46  rgos.bin
   12019754 2008-02-01 08:00:46  s5750_10_4.bin
     399 2006-01-01 08:01:37  config.text
33,030,144 bytes total. (10,590,592 bytes free)

Ruijie(config)# boot system s5750_10_4.bin
Ruijie(config)# show boot system
system boot file: flash:/ s5750_10_4.bin
                        s5750_10_4.bin

```

<b>show boot system</b>	

-

-	-

## 2.2.4 clock set

### clock set

**clock set** *hh:mm:ss month day year*

<i>hh:mm:ss</i>	24 : :
<i>day</i>	1-31
<i>month</i>	1-12
<i>year</i>	1993-2035

---

|

|

|

clock set

|

2003 3 17 10 20 30

Ruijie# **clock set** 10:20:30 3 17 2003

Ruijie# **show clock**

clock: 2003-3-17 10:20:32

|

<b>show clock</b>	

|

|

-	-

## 2.2.5 clock update-calendar

**clock update-calendar**

|

-	-

|

|

|

calendar

---

```
Ruijie# clock update-calendar
```



L

--	--

-

- ÎB1u)ÓÞÛ

AGÅ´



```

|
|
|
|

```

```

10
Ruijie# reload in 10
Router will reload in 600 seconds.

```

-	-

```

|
|

```

-	-

## 2.2.10 session-timeout

```

LINE
no session-timeout
session-timeout minutes [output]
no session-timeout
LINE
LINE

```

<i>minutes</i>	
<b>output</b>	

```

|
|

```

0 min

```

|
|

```

LINE

```

|
|

```

```

LINE
LINE

```

```

|
|

```

```

line vty 0          5 30

```

---

```
Ruijie(config-line)# exec-timeout 5 30
```

-	-

-	-

## 2.2.11 speed

**speed speed**

**no speed**

**speed speed**

<i>Speed</i>	bps 9600 19200 38400 57600 115200 9600

9600

57600 bps

```
Ruijie(config)# line console 0
```

```
Ruijie(config-line)# speed 57600
```

-	-

--	--

---

---

**2.2.12 write**

running-config

**write [ memory | network | terminal ]**

<b>memory</b>	NVRAM running-config startup-config	<b>copy</b>
<b>network</b>	TFTP running-config tftp	<b>copy</b>

```

[Failed]
The device [usb1] does not exist, write to the default config file
[/config.text]? [no] yes
Write to the default config file: [/config.text]
[OK]

```

<b>boot config</b>	
<b>copy</b>	
<b>show running-config</b>	

-	-

## 2.3

### 2.3.1 show clock

**show clock**

**show clock**

-	-

detail

**show clock**

```

Ruijie# show clock
clock: 2003-3-17 10:27:21

```

	<b>clock set</b>	
	-	-

### 2.3.2 show line

#### show line

**show line** [*console line-num* | *aux line-num* | *vty line-num* | *line-num*]

<b>console</b>	
<b>aux</b>	aux
<b>vty</b>	vty
<i>line-num</i>	line

```

|
|
|
|
|

```

```

                                console
Ruijie# show line console 0
CON   Type   speed  Overruns
* 0   CON    9600  45927
Line 0, Location: "", Type: "vt100"
Length: 24 lines, Width: 79 columns
Special Chars: Escape Disconnect Activation
                ^^x   none    ^M
Timeouts:      Idle EXEC   Idle Session
                never     never
History is enabled, history size is 10.

```

---

```
Total input: 53564 bytes
Total output: 395756 bytes
Data overflow: 27697 bytes
stop rx interrupt: 0 times
```

-	-

-	-

### 2.3.3 show reload

**show reload**

**show reload**

-	-

```
Ruijie# show reload
Reload scheduled in 595 seconds.
At 2003-12-29 11:37:42
Reload reason: test.
```

-	-

---

	-	-

### 2.3.4 show running-config

show running-config

show running-config

	-	-

|

|

|

|



	-	-

|

--	--

---

L

---

---

By Ruijie Network

System start time: 1970-6-14 11:49:53

System uptime: 3:17:1:17

System hardware version: 2.0

System software version: RGOS 10.3.00(4), Release(34679)

System boot version: 10.2.34077

System CTRL version: 10.2.24136

System serial number: 1234942570001

-	-

-	-

## 3 LINE

### 3.1 LINE

#### 3.1.1 access-class

Line ACL **access-class** *acl-no* { **in** | **out** }  
Line no **access-class** *access-list-number* { **in** | **out** }  
LINE ACL  
[no] **access-class** *access-list-number* { **in** | **out** }

LINE

	-	-

### 3.1.2 line

LINE

**line** [**aux** | **console** | **tty** | **vty**] *first-line* [*last-line*]

<b>aux</b>		
<b>console</b>		
<b>tty</b>		
<b>vty</b>		telnet/ssh
<i>First-line</i>		first-line
<i>Last-line</i>		last-line

|

|

|

LINE

|

```
LINE VTY 1 3 LINE
Ruijie(config)# line vty 1 3
```

|

	-	-

|

|

	-	-

### 3.1.3 line vty

VTY

no

VTY

**line vty** *line-number*

**no line vty** *line-number*

-	-

VTY      5      0-4

--

VTY

1      VTY      20      VTY      0-19

Ruijie(config)# **line vty** 19

2      VTY      10      VTY      0-9

Ruijie(config)# **line vty** 10

-	-

--

-	-

### 3.1.4 transport input

Line      **transport input**      Line

**default transport input**      LINE

**transport input** {all | ssh | telnet | none}

**default transport input**

<b>all</b>	Line
<b>ssh</b>	Line      SSH

LINE

<b>telnet</b>	Line	Telnet
<b>none</b>	Line	

VTY TTY NONE  
**default transport input**

Line

Line VTY VTY **show**  
**running** Line  
**/ input default transport input no transport**  
**transport input none LINE**

```

line vty 0 4 telnet
Ruijie# configure terminal
Ruijie(config)# line vty 0 4
Ruijie(config-line)# transport input telnet

```

<b>show running</b>	
---------------------	--

RGOS10.1

-	-
---	---

---

# 4

## 4.1

### 4.1.1 ping

**ping** [*vrf vrf-name*] [*ip*] [*ip-address* [*length length* ]] [*ntimes times*] [*timeout seconds*] [*data data*] [*source source*] [*df-bit*] [*validate*]



## DNS

### 1 ping

```
Ruijie# ping 192.168.5.1
```

```
Sending 5, 100-byte ICMP Echoes to 192.168.5.1, timeout is 2 seconds:
```

```
< press Ctrl+C to break >
```

```
!!!!
```

```
Success rate is 100 percent (5/5), round-trip min/avg/max = 1/2/10 ms
```

### 2 ping

```
Ruijie# ping 192.168.5.197 length 1500 ntimes 100 timeout 3 data ffff  
source 192.168.4.10
```

```
Sending 100, 1000-byte ICMP Echoes to 192.168.5.197, timeout is 3 seconds:
```

```
< press Ctrl+C to break >
```

```
!!!!!!!!!!!!!!!!!!!!!!!!!!!!!!!!!!!!!!!!!!!!!!!!!!!!!!!!!!!!!!!!!!!!!!!!!!!!  
!!!!!!!!!!!!!!!!!!!!!!!!!!!!!!!!!!!!!!!!!!!!!!!!!!!!!!!!!!!!!!!!!!!!!!!!!!!!
```

```
Success rate is 100 percent (100/100), round-trip min/avg/max = 2/2/3 ms
```

-	-

-	-

## 4.1.2 ping ipv6

```
ping [ipv6] [ip-address [length length ] [ntimes times] [timeout seconds] [data data]  
[source source]
```

<i>ip-address</i>	IPv6

<i>length</i>	
<i>times</i>	
<i>seconds</i>	
<i>data</i>	
<i>source</i>	IPv6 ::1

2                    5                    100Byte                    IP

```

Ping ipv6
  ping ipv6
  ping ipv6
    2            5            100Byte            IP
    '!'                    ':'
      'C'
      ping
ping ipv6
  
```

	-	-
	ipv6	
	-	-

### 4.1.3 traceroute

traceroute

**traceroute** [**vrf**] [*vrf-name*] [**ip** *ip-address*][*ip-address* [**probe** *number* ] [**source** *source*] [**timeout** *seconds*] [**ttl** *minimum maximum*]]

<i>vrf-name</i>	VRF
<i>ip-address</i>	IPv4
<i>number</i>	
<i>source</i>	IPv4 127.0.0.1
<i>seconds</i>	
<i>minimum maximum</i>	

```

2      192.168.9.2      4 msec  4 msec  4 msec
3      192.168.9.1      8 msec  8 msec  4 msec
4      192.168.0.10     4 msec  28 msec 12 msec
5      202.101.143.130  4 msec  16 msec  8 msec
6      202.101.143.154 12 msec  8 msec  24 msec
7      61.154.22.36    12 msec  8 msec  22 msec
                                     IP      61.154.22.36
1 6

```

2 traceroute

```

Ruijie# traceroute 202.108.37.42
< press Ctrl+C to break >
Tracing the route to 202.108.37.42
1      192.168.12.1     0 msec  0 msec  0 msec
2      192.168.9.2      0 msec  4 msec  4 msec
3      192.168.110.1    16 msec 12 msec 16 msec
4      * * *
5      61.154.8.129    12 msec 28 msec 12 msec
6      61.154.8.17     8 msec 12 msec 16 msec
7      61.154.8.250    12 msec 12 msec 12 msec
8      218.85.157.222  12 msec 12 msec 12 msec
9      218.85.157.130  16 msec 16 msec 16 msec
10     218.85.157.77   16 msec 48 msec 16 msec
11     202.97.40.65    76 msec 24 msec 24 msec
12     202.97.37.65    32 msec 24 msec 24 msec
13     202.97.38.162   52 msec 52 msec 224 msec
14     202.96.12.38    84 msec 52 msec 52 msec
15     202.106.192.226  88 msec 52 msec 52 msec
16     202.106.192.174  52 msec 52 msec 88 msec
17     210.74.176.158 100 msec 52 msec 84 msec
18     202.108.37.42   48 msec 48 msec 52 msec
                                     IP      202.108.37.42
1 17 4

```

```

Ruijie# traceroute www.ietf.org
Translating " www.ietf.org "...[OK]
< press Ctrl+C to break >
Tracing the route to 64.170.98.32
1      192.168.217.1    0 msec  0 msec  0 msec
2      10.10.25.1       0 msec  0 msec  0 msec

```

```

3      10.10.24.1      0 msec  0 msec  0 msec
4      10.10.30.1     10 msec  0 msec  0 msec
5      218.5.3.254   0 msec  0 msec  0 msec
6      61.154.8.49   10 msec  0 msec  0 msec
7      202.109.204.210 0 msec  0 msec  0 msec
8      202.97.41.69  20 msec  10 msec  20 msec
9      202.97.34.65  40 msec  40 msec  50 msec
10     202.97.57.222  50 msec  40 msec  40 msec
11     219.141.130.122 40 msec  50 msec  40 msec
12     219.142.11.10  40 msec  50 msec  30 msec
13     211.157.37.14  50 msec  40 msec  50 msec
14     222.35.65.1   40 msec  50 msec  40 msec
15     222.35.65.18  40 msec  40 msec  40 msec
16     222.35.15.109  50 msec  50 msec  50 msec
17     *      *      *
18     64.170.98.32  40 msec  40 msec  40 msec

```

-	-

-

-	-

#### 4.1.4 traceroute ipv6

traceroute ipv6

**traceroute [ipv6 ip-address] [probe number] [timeout seconds] [ttl minimum maximum]**

<i>ip-address</i>	IPv6
<i>number</i>	
<i>seconds</i>	
<i>minimum maximum</i>	TTL

Traceroute ipv6

DNS

traceroute ipv6

1 traceroute ipv6

Ruijie# **traceroute ipv6 3004::1**

< press Ctrl+C to break >

Tracing the route to 3004::1

1	3000::1	0 msec	0 msec	0 msec
2	3001::1	4 msec	4 msec	4 msec
3	3002::1	8 msec	8 msec	4 msec
4	3004::1	4 msec	28 msec	12 msec

IP 3004::1

1 4

2 traceroute ipv6

Ruijie# **traceroute ipv6 3004::1**

< press Ctrl+C to break >

Tracing the route to 3004::1

1	3000::1	0 msec	0 msec	0 msec
2	3001::1	4 msec	4 msec	4 msec
3	3002::1	8 msec	8 msec	4 msec
4	* * *			
5	3004::1	4 msec	28 msec	12 msec

IP 3004::1

1 5 4

-	-

---

--	--	--

- -

---

---

# 5

## 5.1

### 5.1.1 carrier-delay

**carrier-delay**

**no**

**carrier-delay** [ *seconds* ]

**no carrier-delay**

<i>seconds</i>	1 60

2

DCD

DCD            DCD    Down        Up

DCD

                DCD

67CA1BC(Ruijie 1 fig)#12 0.f 640 1 Tf 2481.52 63.interface gigabitethernet12 0.f 65j /TT0 52449

	-	-
--	---	---

### 5.1.2 clear counters

**clear counters** [*interface-id*]

	<i>interface-id</i>	

|

|

	<b>show interfaces</b>	<b>clear</b>
<b>counters</b>		

Ruijie# **clear counters gigabitethernet 1/1**

	<b>show interfaces</b>	

|

	-	-

### 5.1.3 clear interface

**clear interface** *interface-id*

	<i>interface-id</i>	

|

┌

┌

Switch Port,L2 Aggregate port ,Routed port,L3 Aggregate port  
**shutdown no shutdown**

┌

Ruijie# **clear interface gigabitethernet 1/1**

┌

<b>shutdown</b>	

┌

┌

-	-

### 5.1.4 description

no

**description** *string*

**no description**

┌

<i>string</i>	

┌

┌

┌

**show interfaces**

┌

Ruijie(config)# **interface gigabitethernet 1/1**  
Ruijie(config-if)# **description GBIC-1**

┌

<b>show interfaces</b>	

---

	-	-

### 5.1.5 duplex

no

**duplex {auto | full | half}**

**no duplex**

	<b>auto</b>	
	<b>full</b>	
	<b>half</b>	

└──

└──

└──

**show interfaces**

└──

Ruijie(config-if)# **duplex full**

--	--	--

no

**flowcontrol {auto | off | on}**

**no flowcontrol**

<b>auto</b>	
<b>off</b>	
<b>on</b>	

└───┘

└───┘

└───┘

**show interfaces**

└───┘

1/1

Ruijie(config)# **interface gigabitethernet 1/1**

Ruijie(config-if)# **flowcontrol on**

<b>show interfaces</b>	

└───┘

-	-

### 5.1.7 interface aggregateport

no

**interface aggregateport *port-number***

<i>port-number</i>	Aggregate port

└───┘

---

|

|

```
aggregate port    aggregate port  
aggregate port    show  
interfaces    show interfaces aggregateport
```

|

```
Ruijie(config)# interface aggregateport 3  
Ruijie(config-if)#
```

|

<b>show interfaces</b>	

|

-

|

-	-

### 5.1.8 interface fastEthernet

**interface fastEthernet** *mod-num/port-num*

|

--	--

*mod-num/port-num* /

---

	<b>show interfaces</b>	

|

-

	-	-

### 5.1.9 interface giagbitEthernet

**interface gigabitEthernet** *mod-num/port-num*

	<i>mod-num/port-num</i>	/



|

**no**

10G

**interface tenGigabitEthernet** *mod-num/port-num*

<i>mod-num/port-num</i>	/

|

|

|

**no**  
**tenGigabitEthernet**

**show interfaces**    **show interfaces**

|

Ruijie(config)# **interface tenGigabitEthernet** 1/2  
Ruijie(config-if)#

|

<b>show interfaces</b>	

|

|

-	-

### 5.1.11 interface vlan

switch virtual interface SVI

**no**            SVI

**interface vlan** *vlan-id*

**no interface vlan** *vlan-id*

|

<i>vlan-id</i>	VLAN ID

|

---

---

	<b>show interfaces</b>	

---

no

shutdown

no shutdown

	-	-

|

|

|

Ap SVI

show interfaces

no shutdown

1 Ap 1

Ruijie(config)# interface aggregateport 1

Ruijie(config-if)# shutdown

2 Ap 1

Ruijie(config)# interface aggregateport 1

Ruijie(config-if)# ~~no shutdown~~ [<38B905532AFC36502C8>]T61

**snmp trap link-status**

**no snmp trap link-status**

Link SNMP LinkTrap

Ap SVI LinkTrap  
Link SNMP LinkTrap,

1 Link trap  
Ruijie(config)# **interface gigabitEthernet 1/1**  
Ruijie(config-if)# **no snmp trap link-status**  
2 Link trap  
Ruijie(config)# **interface gigabitEthernet 1/1**  
Ruijie(config-if)# **snmp trap link-status**

Ruijie(config-if)# <b>snmp trap link-status</b>	link trap
Ruijie(config-if)# <b>no snmp trap link-status</b>	link trap

-	-

**5.1.16 speed**

**no**

<b>10</b>	10Mbps
<b>100</b>	100Mbps

<b>1000</b>	1000Mbps
<b>10G</b>	10Gbps
<b>auto</b>	

└───┘

└───┘

└───┘

```

Ap                               Ap
      Ap                           show interfaces
      Ap                           SFP
10M    100M

```

└───┘

```

Ruijie(config)# interface gigabitethernet 1/1
Ruijie(config-if)# speed 100

```

⌘

2



VLAN	VLAN	trunk port	VLAN
VLAN	<b>switchport trunk</b>		VLAN
Ruijie(config-if)# <b>switchport mode trunk</b>			
<b>switchport access</b>	accessport	statics	VLAN
<b>switchport trunk</b>	VLAN	trunkport	native
	VLAN	Trunk	
-			-

### 5.1.19 switchport trunk

trunkport native VLAN Trunk VLAN  
no trunk

**switchport trunk {allowed vlan {all | [add | remove | except] *vlan-list* } } native vlan *vlan-id*}**

**no switchport trunk {allowed vlan | native vlan}**

<b>allowed vlan <i>vlan-list</i></b>	Trunk VLAN	VLAN VLAN ID	<i>vlan-list</i> VLAN
	VLAN ID	VLAN ID	-
	10-20		,
	1-10,20-25,30,33		
	all	VLAN	VLAN
	add	VLAN	VLAN
	remove	VLAN	VLAN
	except	VLAN	VLAN
	VLAN		

---

**native vlan** *vlan-id*

---

## 5.2

### 5.2.1 show interfaces

**show interfaces** [*interface-id*] [**counters** | **description** | **status** | **switchport** | **trunk** | **transceiver** [**alarm** | **diagnosis**]]

<i>interface-id</i>	loopback      aggregateport      SVI
<b>counters</b>	
<b>description</b>	link
<b>status</b>	
<b>switchport</b>	
<b>trunk</b>	trunking port      Aggregate port
<b>transceiver</b>	
<b>alarm</b>	None
<b>diagnosis</b>	

```
Ruijie# show interfacesgigabitEthernet 0/1 switchport
Interface Switchport ModeAccess Native Protected VLAN lists
-----
GigabitEthernet 0/1 enabled Access 11 Disabled ALL
```

<b>duplex</b>	

<b>interface gigabitEthernet</b>	
<b>interface aggregateport</b>	
<b>interface vlan</b>	switch virtual interface SVI
<b>shutdown</b>	
<b>speed</b>	
<b>switchport priority</b>	802.1q
<b>switchport protected</b>	

-	-

# 6 Aggregate Port

## 6.1

### 6.1.1 aggregateport load-balance

AP no

**aggregateport load-balance {dst-mac | src-mac | src-dst-mac | dst-ip | src-ip | src-dst-ip }**

**no aggregateport load-balance**

<b>dst-mac</b>	MAC	MAC	AP
<b>src-mac</b>	MAC	MAC	AP
<b>src-dst-ip</b>	IP	IP	IP— IP—
<b>dst-ip</b>	IP	IP	AP
<b>src-ip</b>	IP	IP	AP
<b>src-dst-mac</b>	MAC—	MAC	MAC—

MAC

```
show aggregateport load-balance
```

```
Ruijie(config)# aggregateport load-balance dst-mac
```

show aggregateport load-balance	
	aggregateport

```
-
```

Aggregate Port

no

Aggregate Port

**port-group** *port-group-number*

**no port-group**

<i>port-group-number</i>	Aggregate Port Port	Aggregate

Aggregate Port

AP

VLAN

trunk port

native

VLAN

AP

1/3 AP 3

```
Ruijie(config)# interface gigabitethernet 1/3
```

```
Ruijie(config-if)# port-group 3
```

-	-
---	---

	-	
	-	-

**6.2**

e9(eg-9(eg))1(-5pte Port)

# 7 VLAN

## 7.1

### 7.1.1 name

VLAN **no**

**name** *vlan-name*

**no name**

	<i>vlan-name</i>	VLAN

VLAN	VLAN	VLAN ID	VLAN 2	"VLAN0002"
------	------	---------	--------	------------

VLAN		
------	--	--

<b>show vlan</b>	vlan	
------------------	------	--

```
Ruijie(config)# vlan 10
Ruijie(config-vlan)# name vlan10
```

<b>show vlan</b>		VLAN

--	--	--

	-	-

### 7.1.2 switchport access

**no** access port VLAN VLAN

**switchport access vlan *vlan-id***

**no switchport access vlan**

<b>access</b>	switch port	access port
<b>trunk</b>	switch port	trunk port
<b>hybrid</b>	switch port	hybrid port

**no switchport trunk {allowed vlan | native vlan }**

<b>allowed vlan</b> <i>vlan-list</i>	Trunk	VLAN	vlan-list
	VLAN		VLAN
	VLAN ID	VLAN ID	-
	10-20		,
	1-10,20-25,30,33		
	all	VLAN	VLAN
add	VLAN	VLAN	
remove	VLAN	VLAN	
except	VLAN	VLAN	
	VLAN		
<b>native vlan</b> <i>vlan-id</i>	Native VLAN		

VLAN all Native VLAN VLAN 1

**Native VLAN**

Trunk native VLAN native VLAN  
 UNTAG VLAN VLAN ID  
 IEEE 802.1Q PVID native VLAN VLAN ID Trunk  
 native VLAN UNTAG

**VLAN**

Trunk VLAN 1 4094  
 Trunk VLAN VLAN Trunk

**show interfaces switchport**

```

VLAN 2 1/15
Ruijie(config)# interface fastethernet 1/15
Ruijie(config-if)# switchport trunk allowed vlan remove 2
Ruijie(config-if)# end
Ruijie# show interfaces fastethernet1/15 switchport
Interface Switchport Mode Access Native Protected VLAN lists
-----
FigabitEthernet 1/15 enabled TRUNK 1 1 Disabled 1,3-4094
    
```

--	--	--

VLAN

-	-
---	---

## 7.2

### 7.2.1 show vlan

VLAN

**show vlan** [*id vlan-id*]

<i>vlan-id</i>	VLAN ID
----------------	---------

**end**                      **Ctrl+C**  
**exit**

Ruijie# **show vlan id 1**

VLAN Name	Status	Ports
1 VLAN0001	STATIC	Fa0/1, Fa0/2

name	VLAN
switchport access	Vlan

-	-
---	---

## 8 Private VLAN

### 8.1

#### 8.1.1 private-vlan association

secondary VLAN primary VLAN

**private-vlan association** {*svlist* | **add** *svlist* | **remove** *svlist*}

**no private-vlan association**

**private-vlan mapping** {*svlist* | **add** *svlist* | **remove** *svlist*}

**no private-vlan mapping**

<i>svlist</i>	secondary VLAN list
<b>no</b>	

┌

┌ Primary VLAN

┌

```
Ruijie(config)# interface vlan 22
Ruijie(config-if)# private-vlan mapping add 24-26
```

<b>show vlan private-vlan</b>	-

┌ RGOS10.1

-	-

### 8.1.3 private-vlan type

VLAN VLAN

**private-vlan** {*community* | *isolated* | *primary*}

**no private-vlan** {*community* | *isolated* | *primary*}

<i>community</i>	community VLAN
<i>isolated</i>	isolated VLAN
<i>primary</i>	primary VLAN
<i>no</i>	VLAN

┌ VLAN

┌ VLAN

┌

┌ Ruijie(config)# **vlan 22**  
Ruijie(config-vlan)# **private-vlan primary**



	<b>show vlan private-vlan</b>	-
	RGOS10.1	
	-	-

### 8.1.5 switchport private-vlan host-association

private VLAN

primary VLAN

secondary VLAN

**switchport private-vlan host-association** *p\_vid s\_vid*

**no switchport private-vlan host-association**

	<i>p_vid</i>	primary VID
	<i>s_vid</i>	secondary VID
	<b>no</b>	VLAN

┌  
└  
┌  
└  
┌  
└

```
Ruijie(config)# interface gigabitEthernet 0/1
Ruijie(config-if)# switchport mode private-vlan host
Ruijie(config-if)# switchport private-vlan host-association 22 23
```

OS 1 1.006 T		TO 1.994.02 0 0 10.02 439.32 12541.60 1 Tf1198 -0.



**show vlan private-vlan [community | primary | isolated]**

<b>primary</b>	primary VLAN
<b>community</b>	community VLAN
<b>isolated</b>	isolated VLAN

private VLAN

Ruijie# **show vlan private-vlan**

-	-

RGOS10.1

-	-

## 8.3 Hybrid

### 8.3.1 switchport hybrid allowed vlan

**switchport hybrid allowed vlan**[[add][tagged | untagged] | remove] *vlist*

**no switchport hybrid allowed vlan**

hybrid

<b>no</b>	hybrid

L

L

L

L

L

L

L

L

L

L

L

L

L

	-	-

### 8.3.3 switchport mode hybrid

**switchport mode hybrid**

**no switchport mode**

hybrid

<b>no</b>		hybrid

┌

┌

┌

┌

Ruijie(config-if)# **switchport mode hybrid**

--	--

## 9 802.1Q Tunneling

### 9.1

#### 9.1.1 frame-tag tpid tpid

tpid

**frame-tag tpid** <tpid>

**no frame-tag tpid**

	<b>no</b>	

┌

┌

┌

```
Ruijie(config)# interface g0/3
Ruijie(config-if)# frame-tag tpid 9100
Ruijie(config-if)# end
Ruijie# show frame-tag tpid
Port      tpid
-----  -
Gi0/3     0x9100
```

	<b>show frame-tag tpid</b>	-

┌

RGOS10.1

	-	-

## 9.1.2 inner-priority-trust enable

```

/
tag tag

```

```

inner-priority-trust enable

```

```

no inner-priority-trust enable

```

			<b>EÄ</b>
<b>no</b>		tag	tag

```

└───┬───┘

```

```

└───┬───┘

```

```

└───┬───┘

```

```

Ruijie(config)#

```



<b>show vlan private-vlan</b>	-

RGOS10.1

-	-

## 9.2

### 9.2.1 show frame-tag tpid

private VLAN

**show frame-tag tpid [interface <interface>]**

<i>interface</i>	

tpid

```
Ruijie# show frame-tag tpid
Ruijie# show frame-tag tpid interface gi0/1
Port    tpid
-----
Gi0/1   0x9100
```

-	-

RGOS10.1

-	-

## 9.2.2 show inner-priority-trust

### show inner-priority-trust

-	-

└───

└───

└───

```
Ruijie# show inner-priority-trust
Port    inner-priority-trust
----    -
Gi0/1   enable
```

-	-

└─── RGOS10.1

-	-

# 10 Share VLAN

## 10.1

### 10.1.1 share

share vlan



Status	duplicated share vlan	Status	original	Status
--------	--------------------------	--------	----------	--------

	-		-	

|

|

|

**end**                      Ctrl+C  
**exit**

```
Ruijie# show mac-address-table share
Vlan  MAC Address      Type      Interface  Status
-----
  1    0040.4650.1e1e  DYNAMIC  Gigabit 0/1  original
  2    0040.4650.1e1e  DYNAMIC  Gigabit 0/1  duplicated
```

	-		-	

|

	-		-	

# 11 MAC

## 11.1

### 11.1.1 address-bind

1 1 . 1 .

/

**address-bind install**

**no address-bind install**

	-	-

|

|

|

```

fa 0/1
Ruijie(config)# address-bind uplink fa0/1
Ruijie(config)# address-bind install
    
```

	<b>show address-bind uplink</b>	

|

RGOS10.1

	-	-

### 11.1.3 address-bind ip-address

ip mac .

**address-bind ip-address mac-address**

**no address-bind ip-address**

	<i>ip-address</i>	IP
	<i>mac-address</i>	mac

|

MAC

┌

┌

┌

┌

┌

┌

IP                    MAC                    IP                    IP  
MAC                    MAC

ip            3.3.3.3    mac        00d0.f811.1112  
Ruijie(config)# **address-bind** 3.3.3.3 00d0.f811.1112

<b>show address-bind</b>	

-	
-	-

### 11.1.4 address-bind ipv6-mode

ip            IP

**address-bind ipv6-mode compatible**

**address-bind ipv6-mode loose**

**address-bind ipv6-mode strict**

┌

┌

┌

┌

-	-

:

	IPv4
	IPv4+MAC
	IPv4+MAC
	IPv4+MAC

	IPv6	
	ipv6	
	IPv6	
	MAC	MAC IPv6

```

IP      192.168.5.2      00d0.f822.33aa
IPv6
Ruijie# configure t
Enter configuration commands, one per line. End with CNTL/Z.
Ruijie(config)# address-bind 00d0.f822.33aa ip 192.168.5.2
Ruijie(config)# address-bind ipv6-mode compatible
    
```

-	-

-	-

### 11.1.5 address-bind uplink

```

ip      mac      .
address-bind uplink intf-id
no address-bind uplink intf-id
    
```

<i>intf-id</i>	

└─┬─

└─┬─

IP                    MAC                    IP                    IP  
MAC                    IP                    MAC  
( address-bind install)

└─┬─

fa 0/1  
Ruijie(config)#**address-bind uplink** fa0/1

└─┬─

<b>show address-bind uplink</b>	

└─┬─

RGOS10.1

└─┬─

-	-

### 11.1.6 clear mac-address-table dynamic

**clear mac-address-table dynamic**[address *mac-addr*] [interface *interface-id*] [vlan *vlan-id*]

└─┬─

<b>dynamic</b>	
<b>address</b> <i>mac-addr</i>	
<b>interface</b> <i>interface-id</i>	
<b>vlan</b> <i>vlan-id</i>	VLAN

└─┬─

└─┬─

└─┬─

**show mac-address-table dynamic**

```
Ruijie# clear mac-address-table dynamic
```

<b>show mac-address-table dynamic</b>	

-	-

### 11.1.7 clear mac-address-table filtering

**clear mac-address-table filtering** [**address** *mac-addr*] [**vlan** *vlan-id*]

<b>filtering</b>	
<b>address</b> <i>mac-addr</i>	
<b>vlan</b> <i>vlan-id</i>	VLAN

```
show mac-address-table filtering
```

```
00d0.f800.0c0c
```

```
Ruijie# clear mac-address-table filtering address 00d0.f800.0c0c
```

<b>mac-address-table filtering</b>	
<b>show mac-address-table filtering</b>	

--	--	--

**no mac-address-table aging-time**



**show mac-address-table filtering**

Ruijie(config)# **mac-address-table filtering 00d0f8000000 vlan 1**

<b>clear mac-address-table filtering</b>	
<b>show mac-address-table filtering</b>	

-	-

### 11.1.11 mac-address-table notification

MAC **no**

**mac-address-table notification [interval *value* | history-size *value*]**

**no mac-address-table notification [interval | history-size]**

<b>interval <i>value</i></b>	MAC	Trap	1
<b>history-size <i>value</i></b>	MAC		50

1 50

MAC Trap  
**snmp-server enable traps mac-notification**  
 MAC Trap

Ruijie(config)# **mac-address-table notification**  
 Ruijie(config)# **mac-address-table notification interval 40**  
 Ruijie(config)# **mac-address-table notification history-size 100**



<b>show mac-address-table static</b>	
<b>clear mac-address-table static</b>	

-

-	-

### 11.1.13 snmp trap mac-notification

MAC no

**snmp trap mac-notification {added | removed}**

**no snmp trap mac-notification {added | removed}**

<b>added</b>	
<b>removed</b>	

**show mac-address-table notification *interface***

```
Ruijie(config)# interface gigabitethernet 1/1
Ruijie(config-if)# snmp trap mac-notification added
```

<b>mac-address-table notification</b>	MAC
<b>show mac-address-table notification</b>	MAC

--	--

MAC

---

	-	
	-	

### 11.1.14 mac-address-learning

/

	<b>mac-address-learning</b>	
		MAC
	1	
	Ruijie(config-if)# no mac-address-learning	

## 11.2

### 11.2.1 show address-bind

	<b>show address-bind</b>	

|

|

```
Ruijie# show address-bind
IP Address      Binding MAC Addr
-----
3.3.3.3         00d0.f811.1112
3.3.3.4         00d0.f811.1117
```

|

<b>address-bind</b>	

|

|

-	-

### 11.2.2 show address-bind uplink

#### show address-bind uplink

|

|

|

|

|

```
Ruijie# show address-bind uplink
Ports      State
-----
Fa0/1      Disabled
Fa0/2      Disabled
```

MAC

.....

<b>address-bind uplink</b>	

-	-

### 11.2.3 show mac-address-table address

MAC

**show mac-address-table** [**address** *mac-addr*] [**interface** *interface-id*] [**vlan** *vlan-id*]

<b>address</b> <i>mac-addr</i>	MAC
<b>interface</b> <i>interface-id</i>	
<b>vlan</b> <i>vlan-id</i>	VLAN

Ruijie#

<b>show mac-address-table interface</b>	
<b>show mac-address-table vlan</b>	VLAN
<b>show mac-address-table count</b>	
<b>show mac-address-table static</b>	
<b>show mac-address-table filtering</b>	

A		
---	--	--

--	--

### 11.2.5 show mac-address-table count

**show mac-address-table count**

-	-

└───

└───

└───

```
Ruijie# show mac-address-table count
Dynamic Address Count : 51
Static Address Count : 0
Filter Address Count : 0
Total Mac Addresses : 51
Total Mac Address Space Available: 8139
```

<b>show mac-address-table static</b>	
<b>show mac-address-table filtering</b>	
<b>show mac-address-table dynamic</b>	
<b>show mac-address-table address</b>	
<b>show mac-address-table interface</b>	
<b>show mac-address-table vlan</b>	VLAN

└───

-	-

## 11.2.6 show mac-address-table dynamic

**show mac-address-table dynamic** [**address** *mac-addr*] [**interface** *interface-id*] [**vlan** *vlan-id*]

<i>mac-addr</i>	MAC
<i>vlan-id</i>	VLAN
<i>interface-id</i>	( AggregatePort)

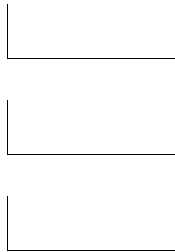

Ruijie# **show mac-address-table dynamic**

Vlan	MAC Address	Type	Interface
----	-----	-----	-----
1	0000.0000.0001	DYNAMIC	gigabitethernet 1/1
1	0001.960c.a740	DYNAMIC	gigabitethernet 1/1
1	0007.95c7.dff9	DYNAMIC	gigabitethernet 1/1
1	0007.95cf.eee0	DYNAMIC	gigabitethernet 1/1
1	0007.95cf.f41f	DYNAMIC	gigabitethernet 1/1
1	0009.b715.d400	DYNAMIC	gigabitethernet 1/1
1	0050.bade.63c4	DYNAMIC	gigabitethernet 1/1

<b>clear mac-address-table dynamic</b>	
--	--



-	-
---	---

## 11.2.7 show mac-address-table filtering

**show mac-address-table static** [**addr** *mac-addr*] [**vlan** *vlan-id*]

--	--

*mac-addr*



<b>interface</b> <i>interface-id</i>	MAC
<i>history</i>	MAC

MAC
-----

```

Ruijie# show mac-address-table notification interface
Interface          MAC Added Trap  MAC Removed Trap
-----
GigabitEthernet1/14  Disabled        Disabled
Ruijie# show mac-address-table notification
MAC Notification Feature : Disabled
Interval between Notification Traps : 1 secs
Maximum Number of entries configured in History Table :1
Current History Table Length : 0
Ruijie# show mac-address-table notification history
History Index : 0
MAC Changed Message :
Operation:ADD Vlan : 1 MAC Addr: 00f8.d012.3456 GigabitEthernet 3/1
    
```

<b>mac-address-table notification</b>	MAC
<b>snmp trap mac-notification</b>	MAC

-	-
---	---

### 11.2.10 show mac-address-table static

**show mac-address-table static** [**addr** *mac-addr*] [**interface** *interface-id*] [**vlan** *vlan-id*]

<i>mac-addr</i>	MAC
<i>vlan-id</i>	VLAN
<i>interface-id</i>	( AggregatePort)

Ruijie# **show mac-address-table static**

Vlan	MAC Address	Type	Interface
-----	-----	-----	-----
1	00d0.f800.1001	STATIC	gigabitethernet 1/1
1	00d0.f800.1002	STATIC	gigabitethernet 1/1
1	00d0.f800.1003	STATIC	gigabitethernet 1/1

<b>mac-address-table static</b>	
<b>clear mac-address-table static</b>	

-	-

### 11.2.11 show mac-address-table vlan

VLAN

**show mac-address-table vlan [vlan-id]**

<i>vlan-id</i>	VLAN ID

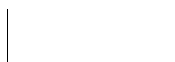

```
Ruijie# show mac-address-table vlan 1
Vlan    MAC Address      Type      Interface
-----  -
1       00d0.f800.1001   STATIC    gigabitethernet 1/1
1       00d0.f800.1002   STATIC    gigabitethernet 1/1
1       00d0.f800.1003   STATIC    gigabitethernet 1/1
```

<b>show mac-address-table static</b>	
<b>show mac-address-table filtering</b>	
<b>show mac-address-table dynamic</b>	
<b>show mac-address-table address</b>	
<b>show mac-address-table interface</b>	
<b>show mac-address-table count</b>	

|

1

# 12 DHCP Snooping

## 12.1 DHCP snooping

### 12.1.1 ip dhcp snooping

```
DHCP Snooping                                no
      DHCP Snooping
```

**[no] ip dhcp snooping**

-	-

└──

└──

DHCP Snooping	show ip dhcp snooping	DHCP
<hr/>		
⚡	DHCP Snooping	Private VLAN

└──

```

DHCP snooping
Ruijie# configure terminal
Ruijie(config)# ip dhcp snooping
Ruijie(config)# end
Ruijie# show ip dhcp snooping

Switch DHCP snooping status    ENABLE
Verification of hwaddr field status  DISABLE
DHCP snooping database write-delay time: 0 seconds
DHCP snooping option 82 status: ENABLE
DHCP snooping Support Bootp bind status: ENABLE
Interface                Trusted    Rate limit (pps)
-----                -

```

--	--

<b>show ip dhcp snooping</b>		DHCP snooping
-	-	-

### 12.1.2 ip dhcp snooping bootp-bind

```

DHCP Snooping   Bootp
no               DHCP snooping   Bootp
    
```

**[no] ip dhcp snooping bootp-bind**

-	-

```

                DHCP Snooping   Bootp
Snooping       Bootp           Bootp   DHCP
Snooping       Bootp           DHCP
    
```

```

                DHCP Snooping   Bootp
Ruijie# configure terminal
Ruijie(config)# ip dhcp snooping bootp-bind
Ruijie(config)# end
Ruijie# show ip dhcp snooping
Switch DHCP snooping status   ENABLE
Verification of hwaddr field status   DISABLE
DHCP snooping database write-delay time: 0 seconds
DHCP snooping option 82 status: ENABLE
DHCP snooping Support Bootp bind status: ENABLE
Interface           Trusted           Rate limit (pps)
-----
    
```

	<b>show ip dhcp snooping</b>	DHCP snooping

└───┘

	-	-

### 12.1.3 ip dhcp snooping database write-delay

DHCP Snooping

no

FLASH

FLASH

**ip dhcp snooping database write-delay time**

**[no] ip dhcp snooping database write-delay**

	<i>time</i>	DHCP snooping	FLASH

└───┘

FLASH

└───┘

└───┘

DHCP Snooping

FLASH

IP

flash

3600

Ruijie# **configure terminal**

Ruijie(config)# **ip dhcp snooping database write-delay 3600**

Ruijie(config)# **end**

Ruijie# **show ip dhcp snooping**

Switch DHCP snooping status ENABLE

Verification of hwaddr field status DISABLE

DHCP snooping database write-delay time: 3600seconds

DHCP snooping option 82 status: ENABLE

DHCP snooping Support Bootp bind status: ENABLE

Interface Trusted Rate limit (pps)

-----

	<b>show ip dhcp snooping</b>	DHCP snooping

└───

	-	-

### 12.1.4 ip dhcp snooping database write-to-flash

DHCP Snooping

FLASH

#### ip dhcp snooping database write-to-flash

	-	-

└───

└───

-	-
---	---

### 12.1.5 ip dhcp snooping information option

DHCP option82  
no

**[no] ip dhcp snooping information option**

-	-
---	---

┌

┌

┌

DHCP option82 DHCP option82

┌

```

DHCP option82
Ruijie# configure terminal
Ruijie(config)# ip dhcp snooping information option
Ruijie(config)# end
Ruijie# show ip dhcp snooping
Switch DHCP snooping status    ENABLE
Verification of hwaddr field status  DISABLE
DHCP snooping database write-delay time: 0 seconds
DHCP snooping option 82 status: ENABLE
DHCP snooping Support Bootp bind status: ENABLE
Interface           Trusted      Rate limit (pps)
-----

```

┌

<b>show ip dhcp snooping</b>	DHCP snooping
------------------------------	---------------

┌

┌

-	-
---	---



[no] ip dhcp snooping verify mac-address

-	-

└───

└───

MAC	DHCP CLIENT	MAC	MAC
DHCP	CLIENT MAC	MAC	

```

                DHCP      MAC
Ruijie# configure terminal
Ruijie(config)# ip dhcp snooping verify mac-address
Ruijie(config)# end
Ruijie# show ip dhcp snooping
Switch DHCP snooping status    ENABLE
Verification of hwaddr field status    ENABLE
DHCP snooping database write-delay time: 0 seconds
DHCP snooping option 82 status: ENABLE
DHCP snooping Support Bootp bind status: ENABLE
Interface                Trusted    Rate limit (pps)
-----                -

```

<b>show ip dhcp snooping</b>	DHCP snooping

└───

-	-

## 12.2 DHCP snooping

### 12.2.1 ip dhcp snooping limit rate

DHCP

no

**[no] ip dhcp snooping limit rate *rate-value***

<i>rate-value</i>	PPS[Packet Per Second]

┌

┌

┌

DHCP Snooping    VLAN  
 CPP[CPU Protect Protocol]    CPP    DHCP  
 CPP    DHCP Snooping

CPP

**show ip dhcp snooping**

1    100pps

```
Ruijie# configure terminal
Ruijie(config)# interface fastEthernet 0/1
Ruijie(config-if)# ip dhcp snooping limit rate 100
Ruijie(config-if)# end
Ruijie# show ip dhcp snooping
Switch DHCP snooping status    ENABLE
Verifi-19( )6(i).56n of hwaddr field
```

	-	-

### 12.2.2 ip dhcp snooping suppression

suppression no  
 no suppression

**[no] ip dhcp snooping suppression**

	-	-

|

|

DHCP DHCP

DHCP

```

Ruijie# configure terminal
Ruijie(config)# interface fastethernet 0/2
Ruijie(config-if)# ip dhcp snooping suppression
Ruijie(config-if)# end
    
```

**fastethernet 0/2 suppression**

Ruijie# **configure terminal**

Ruijie(config)# **interface fastethernet 0/2**

Ruijie(config-if)# **ip dhcp snooping suppression**

Ruijie(config-if)# **end**

	-	-

|

	-	-

### 12.2.3 ip dhcp snooping trust

DHCP snooping TRUST  
 no UNTRUST

**[no] ip dhcp snooping trust**

-	-

UNTRUST

	DHCP	DHCP	TRUST	TRUST
	DHCP	UNTRUST	DHCP	

**fastEthernet 0/1 TRUST**

```

Ruijie# configure terminal
Ruijie(config)# interface fastEthernet 0/1
Ruijie(config-if)# ip dhcp snooping trust
Ruijie(config-if)# end
Ruijie# show ip dhcp snooping
Switch DHCP snooping status    ENABLE
Verification of hwaddr field status  DISABLE
    
```

## **12.3 DHCP snooping**

### **12.3.1 show ip dhcp snooping**

┌

┌

-	-

### 12.3.2 show ip dhcp snooping binding

DHCP Snooping

**show ip dhcp snooping binding**

┌

-	-

┌

┌

┌

DHCP Snooping

```
Ruijie# show ip dhcp snooping binding
Total number of bindings: 1

MacAddress      IPAddress      Lease(sec)  Type         VLAN  Interface
-----
0000.0000.0001  1.1.1.1       78128      dhcp-snooping  1    FastEthernet 0/1
```

┌

<b>ip dhcp snooping binding</b>	DHCP snooping
<b>clear ip dhcp snooping binding</b>	DHCP snooping

┌

┌

--	--



DHCP Snooping

**debug ip dhcp snooping {**

## 13 IGMP Snooping

### 13.1

#### 13.1.1 deny

	profile	profile	deny
<b>deny</b>			
	<b>deny</b>		profile
	profile	deny	
	profile		
	profile	range	profile
	profile		

profile profile permit profile

**permit**

<b>permit</b>	profile

profile deny

profile

profile range profile  
profile

224.2.2.2 profile  
Ruijie(config)# **ip igmp profile 1**  
Ruijie(config-profile)# **range 224.2.2.2**  
Ruijie(config-profile)# **permit**

<b>ip igmp profile</b>	profile
<b>range</b>	

-	-

### 13.1.3 range

profile profile range  
no

**range** *low-ip-address* [*high-ip-address*]

**no range** *low-ip-address* [*high-ip-address*]

<i>low-ip-address</i>	



```

IGMP Profiles
profile
SVGL
IGMP Filtering
profile
    
```

```

1 profile profile
Ruijie(config)# ip igmp profile 1
Ruijie(config-profile)#
    
```

<b>range</b>	profile	
<b>permit</b>	profile	permit
<b>deny</b>	profile	deny

```

    
```

-	-

### 13.1.5 ip igmp snooping ivgl

```

igmp snooping ivgl
no igmp snooping
ip igmp snooping ivgl
    
```

**ip igmp snooping ivgl**

**no ip igmp snooping**

-	-

```

disable
    
```

```

    
```

```

VLAN
VLAN
VLAN
VLAN
    
```

```

pim snooping          igmp snooping  IVGL  IVGL-SVGL
no ip igmp snooping  igmp snooping
pim snooping          pim snooping
    
```

```

Ruijie(config)# ip igmp snooping ivgl
    
```

<b>ip igmp snooping svgl</b>	igmp snooping	svgl
<b>ip igmp snooping ivgl-svgl</b>	igmp snooping	

-	-
---	---

### 13.1.6 ip igmp snooping vlan

```

vlan          igmp snooping          ivgl          ip igmp
snooping vlan          no          igmp snooping
ip igmp snooping vlan vid
no ip igmp snooping vlan vid
    
```

vid	vlan id
-----	---------

disable

```

vlan          IGMP Snooping
vlan          pim snooping          igmp snooping
no ip igmp snooping vlan          igmp snooping
pim snooping          VLAN          pim snooping
    
```



	-	-

### 13.1.8 ip igmp snooping svgl profile

profile SVGL

```
77 ID806 Td( )T/C Td(8.796 1 Tf-E3>JT/TT<350E2CD516/T1 1 Tf0 Tr 4.01/C)5fb1G4jv 14018 Tc 5.2390
@ 17... U6
}
```

**no ip igmp snooping dyn-mr-aging-time**

	<i>time</i>	, <1-3600>

300s

Hello

IGMP

PIM

100s

Ruijie(config)# **ip igmp snooping dyn-mr-aging-time 100**



```
IP          IGMP
```

```
IP          IGMP
```

```
igmp snooping fast-leave
```

```
Ruijie(config)# ip igmp snooping fast-leave enable
```

```
© [REDACTED]
```



	<b>ip igmp snooping source-check default-server</b>	IP IP

	-
--	---

### 13.1.14 ip igmp snooping mrouter learn pim-dvmrp

IGMP Query/Dvmrp/PIM Hello  
**ip igmp snooping mrouter learn**                      no

**ip igmp snooping mrouter learn pim-dvmrp**

**no ip igmp snooping mrouter learn pim-dvmrp**

┌

┌

```

no
                                no
                                vlan
                                vlan
                                vlan
                                igmp snooping
    
```

┌

Ruijie(config)# **ip igmp snooping mrouter learn pim-dvmrp**

<b>ip igmp snooping vlan mrouter learn pim-dvmrp</b>	vlan

┌

-	-

### 13.1.15 ip igmp snooping vlan mrouter interface

```

ip igmp snooping vlan mrouter interface          no
ip igmp snooping vlan vid mrouter interface interface-id
no ip igmp snooping vlan vid mrouter interface interface-id
    
```

<i>vid</i>	vlan id
<i>interface-id</i>	id

┌

┌

┌ IP

```

Ruijie(config)# ip igmp snooping vlan 1 mrouter interface
fastEthernet 0/1
    
```

<b>ip igmp snooping source-check port</b>	

┌

-	-

### 13.1.16 ip igmp snooping vlan mrouter learn pim-dvmrp

IGMP Query/Dvmrp/PIM Hello

*vid*

**vlan id**

<i>vid</i>	vlan id
<i>ip-addr</i>	
<i>interface-id</i>	id

|

|

|

```
Ruijie(config)# ip igmp snooping vlan 1 static 224.0.0.2 interface
fastEthernet 0/1
```

<b>ip igmp snooping vlan mrouter interface</b>	

|

-	-

### 13.1.18 ip igmp snooping filter

profile no profile

**ip igmp snooping filter** *profile-number*

**no ip igmp snooping filter** *profile-number*

<i>profile-number</i>	profile <1-65536>

|

|

IGMP Profile

IGMP Report

IGMP Profile

profile

filter

0/1

profile 1

Ruijie(config)# **interface fastEthernet 0/1**

Ruijie(config-if)# **ip igmp snooping filter 1**

<b>ip igmp profile</b>	profile

--	--

	<b>ip igmp snooping filter</b>	
	-	-

## 13.2

### 13.2.1 show ip igmp snooping

igmp snooping

**Show ip igmp snooping [gda-table | interfaces | mrouter/ statistics [vlan *vlan-id* ]**

	igmp snooping
<b>gda-table</b>	
<b>interfaces</b>	igmp snooping filtering
<b>mrouter</b>	
<b>statistics [vlan <i>vlan-id</i>]</b>	snooping



**undebg igmp-snp event**

**undebg igmp-snp packet**

**undebg igmp-snp msf**

**undebg igmp-snp warning**

	IGMP Snooping
<b>event</b>	IGMP Snooping
<b>packet</b>	IGMP Snooping
<b>msf</b>	IGMP Snooping
<b>warning</b>	IGMP Snooping

EXEC

# 14 DHCPV6 Snooping

## 14.1

### 14.1.1 ipv6 dhcp snooping

```
dhcpv6 snooping no dhcpv6  
snooping
```

```
ipv6 dhcp snooping
```

```
no ipv6 dhcp snooping
```

	-	-

```
|
```

```
|
```

```
|
```

```
dhcpv6 snooping show ipv6 dhcp  
snooping dhcpv6 snooping
```

```
|
```

```
1 dhcpv6 snooping  
Ruijie(config)# ipv6 dhcp snooping
```

```
|
```

show ipv6 dhcp snooping	dhcpv6 snooping

```
|
```

no

**ipv6 dhcp snooping binding-delay *seconds***

**no ipv6 dhcp snooping binding-delay**

	<i>time</i>	

|

|

|

IPv6

1 10

Ruijie(config)# **ipv6 dhcp snooping binding-delay 10**

|

	10.4	

### 14.1.3 ipv6 dhcp snooping database write-delay

dhcpv6 snooping

flash

no

**ipv6 dhcp snooping database write-delay *time***

**no ipv6 dhcp snooping database write-delay**

--	--	--

|

|

dhcpv6 snooping flash  
IP

|

1 flash 100  
Ruijie(config)# **ipv6 dhcp snooping database write-delay 100**

|

<b>show ipv6 dhcp snooping</b>	dhcpv6 snooping

|

|

10.4	

#### 14.1.4 ipv6 dhcp snooping database write-to-flash

|

dhcpv6 snooping flash  
**ipv6 dhcp snooping database write-to-flash**

-	

|

|

dhcpv6 snooping flash  
flash

	10.4	

### 14.1.5 ipv6 dhcp snooping filter-dhcp-pkt

	dhcpv6	no
	<b>ipv6 dhcp snooping filter-dhcp-pkt</b>	
	<b>no ipv6 dhcp snooping filter-dhcp-pkt</b>	
	dhcpv6	dhcpv6
	1 <b>fastethernet 0/1</b>	dhcpv6
	Ruijie(config)# <b>interface fastethernet 0/1</b>	
	Ruijie(config-if)# <b>ipv6 dhcp snooping filter-dhcp-pkt</b>	
	-	-
	10.4	

### 14.1.6 ipv6 dhcp snooping ignore dest-not-found

no DHCPv6

**ipv6 dhcp snooping ignore dest-not-found**

**no ipv6 dhcp snooping ignore dest-not-found**

--	--

┌

┌

DHCPv6	MAC	MAC	DHCPv6	MAC
DHCPV6_SNOOPING-5-DEST_NOT_FOUND: Could not find destination port.				
Destination MAC [mac-address]		DHCPv6		
	MAC			VLAN

1  
Ruijie(config)# **ipv6 dhcp snooping ignore dest-not-found**

<b>show ipv6 dhcp snooping</b>	dhcpv6 snooping

┌

10.4	

### 14.1.7 ipv6 dhcp snooping link-detection

LINK DOWN no

**ipv6 dhcp snooping link-detection**

**no ipv6 dhcp snooping link-detection**

--	--	--

┌

┌

┌

LINK DOWN  
LINK DOWN

┌

1 LINK DOWN  
Ruijie(config)# **ipv6 dhcp snooping link-detection**

┌

<b>show ipv6 dhcp snooping</b>	dhcpv6 snooping

┌

10.4	

### 14.1.8 ipv6 dhcp snooping trust

dhcpv6 snooping trust no  
untrust

**ipv6 dhcp snooping trust**

**no ipv6 dhcp snooping trust**

┌

--	--

┌

untrust

┌

┌

dhcpv6 untrust trust trust dhcpv6 Server  
dhcpv6 Server

```

1          fastethernet 0/1  trust
Ruijie(config)# interface fastethernet 0/1
Ruijie(config-if)# ipv6 dhcp snooping trust
    
```

<b>show ipv6 dhcp snooping</b>	dhcpv6 snooping

<b>10.4</b>	

### 14.1.9 Ipv6 dhcp snooping vlan

```

vlan          dhcpv6 snooping          no
vlan          dhcpv6 snooping
    
```

**ipv6 dhcp snooping** {*vlan-list* | {*vlan-min* [*vlan-max*]}}

**no ipv6 dhcp snooping** {*vlan-list* | {*vlan-min* [*vlan-max*]}}

<i>vlan-list</i>	vlan 1,3-5,7,9-11
<i>vlan-min</i>	vlan id
<i>vlan-max</i>	vlan id

```

dhcpv6 snooping          vlan
    
```

```

dhcpv6 snooping          vlan  dhcpv6 snooping
vlan          dhcpv6 snooping          vlan          dhcpv6 snooping
    
```

```

1  vlan 1          dhcpv6 snooping
Ruijie(config)# no ipv6 dhcp snooping vlan 1
    
```

--	--

	-	-
	10.4	

### 14.1.10 ipv6 source binding

no

**ipv6 source binding** *mac-address* **vlan** *vlan-id* *ipv6-address* **interface** *interface-name*

**no ipv6 source binding** *mac-address* **vlan** *vlan-id* *ipv6-address* **interface** *interface-name*

<i>mac-address</i>	MAC
<i>vlan-id</i>	VLAN
<i>ipv6-address</i>	IPV6
<i>interface-name</i>	

IPV6                      DHCPV6                      IPV6

1

```
Ruijie(config)# ipv6 source binding 00d0.f866.4777 vlan 10
2001:2002::2003 interface fastethernet 0/10
```

--	--

10.4

### 14.1.11 ipv6 verify source

no

**ipv6 verify source [port-security]**

**no ipv6 verify source**

<b>port-security</b>	MAC + IPV6 IPV6 IPV6
	MAC IPV6

┌

┌

┌

IPV6 DHCPV6 IPV6

┌  
 1 fastethernet 0/1 MAC+IPV6  
 Ruijie(config)# interface fastethernet 0/1  
 Ruijie(config-if)# ipv6 verify source port-security

┌

┌

┌

10.4	

## 14.2

### 14.2.1 show ipv6 dhcp snooping

dhcpv6 snooping

**show ipv6 dhcp snooping**

-	-

└───┘

└───┘

└───┘

dhcpv6 snooping

1 dhcpv6 snooping

Ruijie# show ipv6 dhcp snooping

Switch DHCPv6 snooping status ENABLE

DHCPv6 snooping vlan: 1-4094

DHCPv6 snooping database write-delay time: 0 seconds

DHCPv6 ignore dest-not-found :DISABLE

DHCPv6 snooping link detection :DISABLE

Interface	Trusted	Filter DHCP
-----	-----	-----
FastEthernet0/10	yes	DISABLE

└───┘

10.4	

**14.2.2 show ipv6 dhcp snooping binding**

dhcpv6 snooping

**show ipv6 dhcp snooping binding** [ipv6-address] [mac-address] [vlan vlan\_id]  
 [interface interface\_name]



	<b>vlan</b> <i>vlan_id</i>	VLAN
	<b>interface</b> <i>interface_name</i>	

|

|

dhcpv6 snooping



dhcpv6 snooping

**show ipv6 source binding** [*ipv6-address*] [*mac-address*] [**vlan** *vlan\_id*]  
[**interface** *interface\_name*] [**dhcp-snooping** | **static**]

### 14.3.1 clear ipv6 dhcp snooping binding

dhcpv6 snooping

**clear ipv6 dhcp snooping binding** [*ipv6-address*] [*mac-address*] [**vlan** *vlan\_id*]  
[**interface** *interface\_name*]

<i>ipv6-address</i>	ipv6
<i>mac-address</i>	mac
<b>vlan</b> <i>vlan_id</i>	VLAN
<b>interface</b> <i>interface_name</i>	

dhcpv6 snooping

1 dhcpv6 snooping

Ruijie# **clear ipv6 dhcp snooping binding**

10.4	

### 14.3.2 clear ipv6 dhcp snooping prefix

dhcpv6 snooping

**clear ipv6 dhcp snooping prefix** [*ipv6-prefix*] [*mac-address*] [**vlan** *vlan\_id*]  
[**interface** *interface\_name*]

--	--

<i>ipv6-prefix</i>	ipv6
<i>mac-address</i>	mac
<b>vlan</b> <i>vlan_id</i>	VLAN
<b>interface</b> <i>interface_name</i>	

┌

┌

┌

dhcpv6 snooping

┌  
1 dhcpv6 snooping  
Ruijie# **clear ipv6 dhcp snooping prefix**

┌

┌

┌

<b>10.4</b>	

### 14.3.3 clear ipv6 dhcp snooping statistics

dhcpv6 snooping    dhcpv6

**clear ipv6 dhcp snooping statistics**

┌

-	-

┌

┌

┌

dhcpv6 snooping    dhcpv6





	<b>10.4</b>	

# 15 ND Snooping

## 15.1

### 15.1.1 ipv6 nd snooping

```

IPv6 ND snooping                               no          IPv6 ND
Snooping
ipv6 nd snooping
no ipv6 nd snooping

```

--	--

--	--

```

          ipv6 nd snooping

```

```

          IPv6 ND snooping
Ruijie# configure terminal
Enter configuration commands, one per line.  End with CNTL/Z.
Ruijie(config)# ipv6 nd snooping

```

<b>show ipv6 nd snooping</b>	ipv6 nd snooping

--	--

--	--

10.4(2)	

### 15.1.2 ipv6 nd snooping vlan

VLAN IPv6 ND snooping no VLAN  
 IPv6 ND Snooping  
**ipv6 nd snooping vlan {vlan-rng | {vlan-min [vlan-max]}}**  
**no ipv6 nd snooping vlan {vlan-rng | {vlan-min [vlan-max]}}**

<i>vlan-rng</i>	vlan
<i>vlan-min</i>	vlan
<i>vlan-max</i>	vlan

vlan ipv6 nd snooping

1 VLAN 100 IPv6 ND Snooping  
 Ruijie# **configure terminal**  
 Enter configuration commands, one per line. End with CNTL/Z.  
 Ruijie(config)# **no ipv6 nd snooping vlan 100**

2 VLAN 4 5-7 15 IPv6 ND Snooping  
 Ruijie# **configure terminal**  
 Enter configuration commands, one per line. End with CNTL/Z.  
 Ruijie(config)# **no ipv6 nd snooping vlan 4,5-7,15**

<b>show ipv6 nd snooping</b>	ipv6 nd snooping





### 15.1.5 ipv6 nd snooping detect gateway

no

**ipv6 nd snooping detect gateway ra**  
**no ipv6 nd snooping detect gateway ra**

VLAN

Ruijie#

<i>vlan-rng</i>	vlan
<i>vlan-min</i>	vlan
<i>vlan-max</i>	vlan

VALN

```
Ruijie# configure terminal
Enter configuration commands, one per line. End with CNTL/Z.
Ruijie(config)# ipv6 nd snooping detect gateway vlan 8
```

<b>show ipv6 nd snooping</b>	nd snooping

10.4(2)	

### 15.1.7 ipv6 nd snooping key-node

ND

no

```
ipv6 nd snooping key-node [link-local vid]ipv6_address/prefix_len
no ipv6 nd snooping key-node [link-local vid] ipv6_address/prefix_len
```

<i>vid</i>	link-local          VID

<i>ipv6_address/prefix_len</i>	IPv6

```
Ruijie# configure terminal
Enter configuration commands, one per line. End with CNTL/Z.
Ruijie(config)#ipv6 nd snooping key-node 2003::1/128
```

<b>show ipv6 nd snooping key-node</b>	nd snooping

10.4(2)	

### 15.1.8 ipv6 nd snooping monitor stateless-user

no

```
ipv6 nd snooping monitor stateless-user
no ipv6 nd snooping monitor stateless-user
```

ND

Ruijie# **configure terminal**

Enter configuration commands, one per line. End with CNTL/Z.

Ruijie(config)#**no ipv6 nd snooping monitor stateless-user**

<b>show ipv6 nd snooping stateless-user</b>	

10.4(2)	

### 15.1.9 ipv6 nd snooping stateless-user combine-security

no

**ipv6 nd snooping stateless-user combine-security**

**no ipv6 nd snooping stateless-user combine-security**

```
Ruijie# configure terminal
Enter configuration commands, one per line. End with CNTL/Z.
Ruijie(config)# ipv6 nd snooping stateless-user combine-security
```

<b>show ipv6 nd snooping</b>	ipv6 nd snooping

10.4(2)	

### 15.1.10 ipv6 nd snooping stateless-user address-bind

IPv6

no

```
ipv6 nd snooping stateless-user address-bind [strict] [ip-mac]
no ipv6 nd snooping stateless-user address-bind
```

<b>strict</b>	link-local link-local link-local
<b>ip-mac</b>	IP+MAC IP

1

```
Ruijie# configure terminal  
Enter configuration commands, one per line. End with CNTL/Z.  
Ruijie(config)# ipv6 nd snooping stateless-user address-bind  
    2                               IP+MAC  
Ruijie# configure terminal  
Enter configuration commands, one per line. End with CNTL/Z.  
Ruijie(config)#ipv6 nd snooping stateless-user address-bind strict  
ip-mac
```

---

**show ipv6 nd snooping**

---

---

ipv6 nd snooping

---

Enter configuration commands, one per line. End with CNTL/Z.  
Ruijie(config)# **ipv6 nd snooping stateless-user station-move**



<b>show ipv6 nd snooping</b>	ipv6 nd snooping
10.4(2)	

### 15.1.13 ipv6 nd snooping stateless-user per-vlan prefix-limit

```

                VLAN      IPv6
ipv6 nd snooping stateless-user per-vlan prefix-limit num
no ipv6 nd snooping stateless-user per-vlan prefix-limit
    
```

<i>num</i>	VLAN      IPv6

2

```

                VLAN      4      IPv6
Ruijie# configure terminal
Enter configuration commands, one per line. End with CNTL/Z.
Ruijie(config)#ipv6 nd snooping stateless-user per-vlan
prefix-limit 4
    
```

<b>show ipv6 nd snooping</b>	ipv6 nd snooping
------------------------------	------------------

10.4(2)	
---------	--

### 15.1.14 clear ipv6 nd snooping key-node

**clear ipv6 nd snooping key-node [vlan *vid*]**

<i>vid</i>	VLAN

Ruijie# **clear ipv6 nd snooping key-node**

10.4(2)	

### 15.1.15 clear ipv6 nd snooping stateless-user

**clear ipv6 nd snooping stateless-user [vlan *vid*]**

<i>vid</i>	VLAN

```
Ruijie# clear ipv6 nd snooping stateless-user
```

10.4(2)	

### 15.1.16 clear ipv6 nd snooping prefix

VLAN

```
clear ipv6 nd snooping prefix [vid vlan]
```

<i>vlan</i>	VLAN

IPv6

```
Ruijie# clear ipv6 nd snooping prefix
```

--	--



### 15.2.2 show ipv6 nd snooping key-node

**show ipv6 nd snooping key-node**

|

|

|

Ruijie# **show ipv6 nd snooping key-node**

|

10.4(2)	

### 15.2.3 show ipv6 nd snooping stateless-user

```

    ipv6
    show ipv6 nd snooping stateless-user

```

```

```

```

```

```

```

```

    ipv6
    Ruijie# show ipv6 nd snooping stateless-user

```

```

```

10.4(2)	

### 15.2.4 show ipv6 nd snooping prefix

```

    show ipv6 nd snooping prefix

```

```

```

ND Snooping

# 16 MSTP

## 16.1

### 16.1.1 bpdu src-mac-check

bpdu mac no bpdu mac

**bpdu src-mac-check** *H.H.H*

**no bpdu src-mac-check**

<i>H.H.H</i>	mac	bpdu
<b>no</b>	bpdu	

|

|

|

```
Ruijie(config)# interface gigabitethernet 1/1  
Ruijie(config-if)# bpdu src-mac-check 00d0.f800.1e2f
```

-		-

|

[Redacted]

RSTP BPDU BPDU

**clear spanning-tree detected-protocols** [interface *interface-id*]

<i>interface-id</i>	

┌

┌

┌

┌

Ruijie# **clear spanning-tree detected-protocols**

<b>show spanning-tree interface</b>	STP

┌

-	-

### 16.1.3 spanning-tree

MSTP    MSTP    MSTP  
 no                      spanning-tree                      no                      spanning tree

**spanning-tree** [ **forward-time** *seconds* | **hello-time** *seconds* | **max-age** *seconds* ]

**no spanning-tree** [forwa Td[(no spannin)5(g)-10.001 Tc 0.0032 Tw 5.251 0 Td<01C4>TjTT1 1 Tf-0.00

**forward-time hello-time max-age**

$2 * (\text{Hello Time} + 1.0\text{snd}) \leq \text{Max-Age Time} \leq 2 * (\text{Forward-Delay} - 1.0\text{snd})$

1 spanning-tree

Ruijie(config)# **spanning-tree**

2 BridgeForwardDelay

Ruijie(config)# **spanning-tree forward-time 10**

<b>show spanning-tree</b>	STP
<b>spanning-tree mst cost</b>	STP PathCost
<b>spanning-tree tx-hold-count STP</b>	TxHoldCount

-	-

### 16.1.4 spanning-tree autoedge

Autoedge

disabled

Autoedge

**spanning-tree autoedge [disabled]**

<b>disabled</b>	Autoedge

Ruijie(config)#

	-	-
--	---	---

### 16.1.6 spanning-tree bpduguard

	BPDU Guard	enabled	disabled
BPDU Guard			
spanning-tree bpduguard [enable/disable]			
	enabled	EA 7	
	disabled		BPDU Guard

Bä]xa ìÿ= Ã ðÀ % 3• Ð• HNBf9€ f"7Nf9€ v B NöhD†vc Nû4B ñ e%" 0CE I3L> xâ4Ãb3\ LN b2f"R C,



	-	-



root guard





## 16.1.14 spanning-tree mode

STP                    no

**spanning-tree mode [stp | rstp | mstp]**

**no spanning-tree mode**

<b>stp</b>	Spanning tree protocol(IEEE 802.1d)
<b>rstp</b>	Rapid spanning tree protocol(IEEE 802.1w)
<b>mstp</b>	Multiple spanning tree protocol(IEEE 802.1s)

MSTP

.

Ruijie(config)# **spanning-tree mode stp**

<b>show spanning-tree</b>	

-	-



```
VLAN 3 Instance 1 MST
Ruijie(config-mst)# no instance 1 vlan 3
Instance 1
Ruijie(config-mst)# no instance 1
MST show
```



MSTP

MSTP

Region

```

mst 20 GigabitEthernet 1/1 10
Ruijie(config)# interface gigabitEthernet 1/1
Ruijie(config-if)# spanning-tree mst 20 port-priority 0
show spanning-tree mst instance interface interface-id
```

Instance 20

8192

Ruijie(config-if)# **spanning-tree mst 20 priority 8192**

**show spanning-tree mst instance interface interface-id**

■

	<b>show spanning-tree interface</b>	STP
	-	-

### 16.1.20 spanning-tree portfast

	Portfast	disabled	Portfast
	<b>spanning-tree portfast [disabled]</b>		
	<b>disabled</b>	Portfast	
	-		
	<pre>Ruijie(config)# interface gigabitethernet 1/1 Ruijie(config-if)# spanning-tree portfast</pre>		
	<b>show spanning-tree interface</b>	STP	
	-	-	

### 16.1.21 spanning-tree portfast bpdupfilter default

	BPDU filter	no	BPDU filter
	<b>spanning-tree portfast bpdupfilter default</b>		

**no spanning-tree portfast bpduser default**

	-	-

BPDU filter

BPDU Filter

BPDU

**show spanning-tree**

Ruijie(config)# **spanning-tree portfast bpduser default**

<b>show spanning-tree interface</b>		STP

	-	-

**16.1.22 spanning-tree portfast bpduguard default**

BPDU guard

no

BPDU guard

**spanning-tree portfast bpduguard default**

**no spanning-tree portfast bpduguard default**

	-	-

BPDU Guard.

```
Ruijie(config)# spanning-tree portfast bpduguard default
```

<b>show spanning-tree interface</b>	STP

-	-

### 16.1.23 spanning-tree portfast default

Portfast                      no                      Portfast

**spanning-tree portfast default**

**no spanning-tree portfast default**

-	-

Portfast

### 16.1.24 spanning-tree reset

	spanning-tree	no
	<b>spanning-tree reset</b>	
	-	-
	Ruijie(config)# <b>spanning-tree reset</b>	
	<b>show spanning-tree</b>	STP
	<b>show spanning-tree interface</b>	STP
	-	-

### 16.1.25 spanning-tree tc-guard

	tc-guard	no	tc-guard	tc-guard
	tc			
	<b>spanning-tree tc-guard</b>			
	<b>no spanning-tree tc-guard</b>			
	-	-	-	-
	tc-guard			

|

|

|

Ruijie(config-if)# **spanning-tree tc-guard**

|

-	-

|

|

-	-

### 16.1.26 spanning-tree tc-protection

tc- protection

no

tc- protection

**spanning-tree tc- protection**

**no spanning-tree tc- protection**

|

-	-

|

tc- protection

|

|

|

Ruijie(config)# **spanning-tree tc- protection**

|

-	-

|

-	-

### 16.1.27 spanning-tree tc-protection tc-guard

tc-guard                                  no                                  tc-guard                                  tc-guard  
tc

**spanning-tree tc-protection tc-guard**

**no spanning-tree tc-protection tc-guard**

-	-

tc-guard

Ruijie(config)# **spanning-tree tc-protection tc-guard**

-	-

-	-

### 16.1.28 spanning-tree tx-hold-count

STP                  TxHoldCount

MSTP

---

<i>tx-hold-count</i>	TxHoldCount	1	10

3



Ruijie(config)# **spanning-tree tx-hold-count 5**

<b>show spanning-tree</b>	MSTP	

<b>tx-hold-count</b>	TxHoldCount
<b>pathcost method</b>	

|

|

|

|

Ruijie# **show spanning-tree hello-time**



<b>link-type</b>	linktype
------------------	----------

┌

┌

┌

Ruijie# **show spanning-tree interface gigabitethernet 1/5**

<b>spanning-tree bpdupfilter</b>	BPDU filter
<b>spanning-tree portfast</b>	portfast
<b>spanning-tree bpduguard</b>	BPDU guard
<b>spanning-tree link-type</b>	“ ”

┌

-	-
---	---

## 16.2.3 show spanning-tree mst

MST Instance

**show spanning-tree mst** { **configuration** | *instance-id* [ **interface** *interface-id* ] }

<b>configuration</b>	mst
<i>instance-id</i>	<i>Instance</i>
<i>interface-id</i>	

Instance

.

Ruijie# **show spanning-tree mst configuration**



# 17 SPAN

## 17.1

### 17.1.1 monitor session

SPAN . no

**monitor session** *session\_number* {**source interface** *interface-id* [**both** | **rx** | **tx**] | **destination interface** *interface-id* { **encapsulation** | **switch** } | [**both** | **rx** | **tx**]} [**acl name**]

**no monitor session** *session\_number* [**source interface** *interface-id* [**both** | **rx** | **tx**] | **destination interface** *interface-id* { **encapsulation** | **switch** }] | [**both** | **rx** | **tx**] [**acl name**]

**no monitor session all**

<i>session_number</i>	SPAN
<b>source interface</b> <i>interface-id</i>	<i>interface-id</i> SVI
<b>destination interface</b> <i>interface-id</i>	<i>interface-id</i> SVI
<b>mac source</b> <i>mac-addr</i>	MAC
<b>mac destination</b> <i>mac-addr</i>	MAC
<b>both</b> <b>acl name</b>	<b>acl name/id</b>
<b>rx</b>	
<b>tx</b>	
<b>all</b>	
<b>switch</b>	

SPAN

|

|

|

```
show monitor SPAN 1
Ruijie# show monitor session 1
sess-num: 1
src-intf:
GigabitEthernet 3/1 frame-type Both
dest-intf:
GigabitEthernet 3/8
```

|

<b>monitor session</b>	SPAN

|

|

-	-

**18**

```

1/2 //
Ruijie(config)# monitor session 2 destination remote vlan 7
interface gigabitEthernet 1/3 switch //
Ruijie(config)# monitor session 2 destination remote vlan 7
reflector-port interface gigabitEthernet 1/1 switch
2
Ruijie(config)# monitor session 2 remote-destination
Ruijie(config)# monitor session 2 destination remote vlan 7
interface gigabitEthernet 1/1 switch

```

<b>show monitor</b>	

reflector-port

-	-

### 18.1.2 remote-span

RSPAN VLAN

[no] remote-span

-	-

VLAN

end Ctrl+C  
exit

```

Ruijie(config)# vlan 5
Ruijie(config)# remote-span

```

--	--

	<b>show vlan</b>	Vlan
	S2600	
	-	-

# 19 IP

## 19.1

### 19.1.1 ip address

IP

no

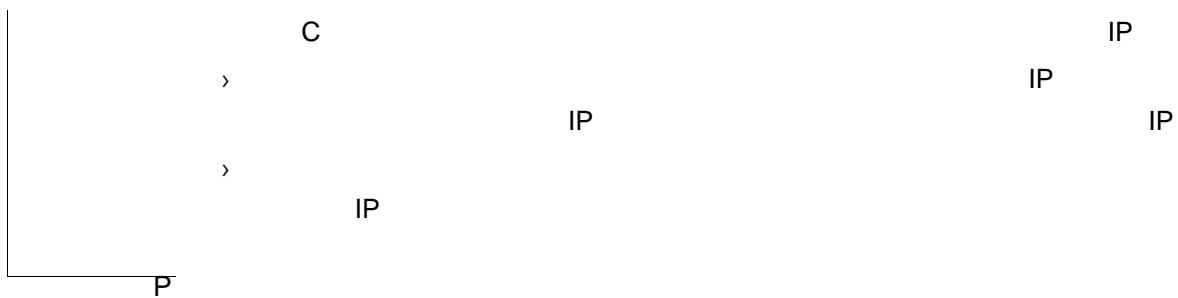

```
IP      10.10.10.1      255.255.255.0
ip address 10.10.10.1 255.255.255.0
```

<b>show interface</b>	

- >
- > SLIP HDLC PPP LAPB Frame-relay X.25
- > ping IP
- > SNMP
- >

|

ARP

|

RGOS

ARP

32

IP

48

MAC

ARP

ARP

clear 0.00.4 c65d(32

```
1 SVI 1 ARP
Ruijie(config)# interface vlan 1
Ruijie(config-if)# arp gratuitous-send interval 1

2 SVI 1 ARP
Ruijie(config)# interface vlan 1
Ruijie(config-if)# no arp gratuitous-send
```

---



IP

---

	<b>Arp retry times</b> <i>number</i>	ARP
--	--------------------------------------	-----

--

IP

---

	-	-
--	---	---

## 19.2.5 arp timeout

ARP

ARP

no

**arp timeout** *seconds*

**no arp timeout**

ARP no

8192

**arp unresolve number**

**no arp unresolve**

<i>number</i>	ARP < 1-8192
	> 8192

ARP 8192

┌

ARP

500

arp unresolved 500

-	-

┌

-	-

### 19.2.7 ip proxy-arp

ARP ip proxy-arp no

ARP

**ip proxy-arp**

**no ip proxy-arp**

-	-

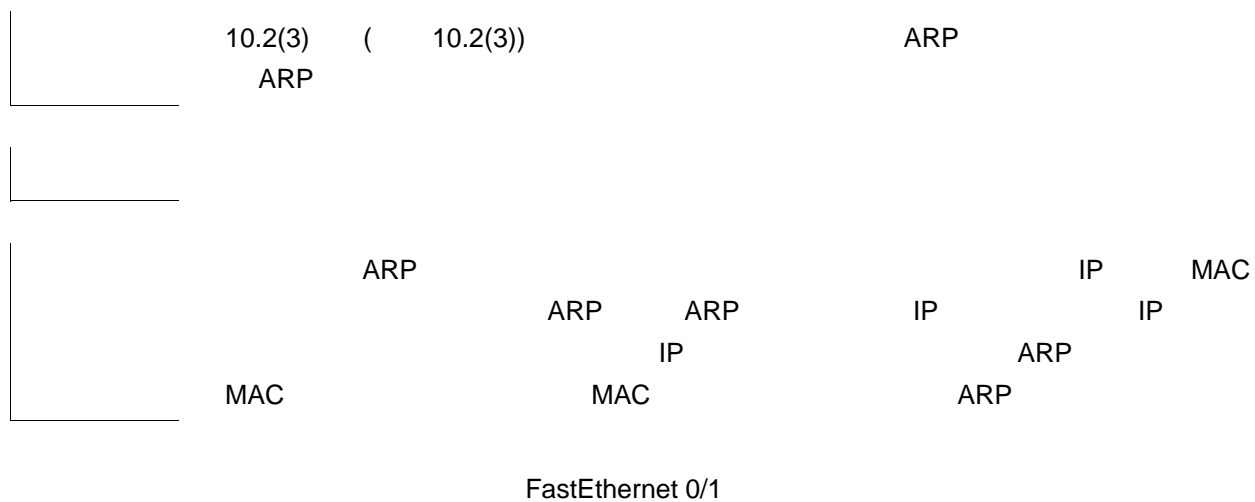

IP

---

*mask*

mask

ARP

<b>vrf</b> <i>vrf_name</i>	VRF	VRF	ARP
<b>trusted</b>	ARP	ARP	VRF
<i>ip</i>	IP <b>trusted</b>	IP	ARP ARP
<i>mask</i>	IP	ARP ;	trusted
<b>static</b>	ARP	ARP	
<del>ARP</del> <i>addre /b</i>		arp	

Age (min)	ARP
Hardware	IP
Type	ARPA
Interface	IP

2 show arp 192.168.195.68

Ruijie# show arp 192.168.195.68

Protocol	Address	Age(min)	Hardware	Type	Interface
Internet	192.168.195.68	1	0013.20a5.7a5f	arpa	VLAN 1

3 show arp 192.168.195.0 255.255.255.0

Ruijie# show arp 192.168.195.0 255.255.255.0

Protocol	Address	Age(min)	Hardware	Type	Interface
Internet	192.168.195.64	0	0018.8b7b.9106	arpa	VLAN 1
Internet	192.168.195.2	1	00d0.f8ff.f00e	arpa	VLAN 1
Internet	192.168.195.5	--	00d0.f822.33b1	arpa	VLAN 1
Internet	192.168.195.1	0	00d0.f8a6.5af7	arpa	VLAN 1
Internet	192.168.195.51	1	0018.8b82.8691	arpa	VLAN 1

4 show arp 001a.a0b5.378d

Ruijie# show arp 001a.a0b5.378d

Protocol	Address	Age(min)	Hardware	Type	Interface
Internet	192.168.195.67	4	001a.a0b5.378d	arpa	VLAN 1

-	-

-	-

### 19.3.3 show arp counter

ARP arp

show arp counter

--	--

-	-
---	---

--

--

--

```

show arp counter
Ruijie# show arp counter
The Arp Entry counter:0
The Unresolve Arp Entry:0
    
```

-	-
---	---

--

-	-
---	---

### 19.3.4 show arp detail

ARP

**show arp detail** [*interface-type interface-number*] *ip* [*mask*] | *mac-address* | **static** | **complete** | **incomplete**]

<i>interface-type interface-number</i>	ARP		
<i>ip</i>	ip	ip	ARP
<i>ip mask</i>	ip mask		ARP

ARP

ARP

**show arp detail**

Ruijie# **show arp detail**

IP Address	MAC Address	Type	Age(min)	Interface	Port
20.1.1.1	000f.e200.0001	Static	-- --	--	
20.1.1.1	000f.e200.0001	Static	-- VI3	--	
20.1.1.1	000f.e200.0001	Static	-- VI3	Gi2/0/1	
193.1.1.70	00e0.fe50.6503	Dynamic	1 VI3	Gi2/0/1	
192.168.0.1	0012.a990.2241	Dynamic	10 Gi2/0/3	Gi2/0/3	
192.168.0.1	0012.a990.2241	Dynamic	20 Ag1	Ag1	
192.168.0.1	0012.a990.2241	Dynamic	30 VI2	Ag2	
192.168.0.39	0012.a990.2241	Local	-- VI3	--	
192.168.0.39	0012.a990.2241	Local	-- Gi2/0/3	--	
192.168.0.1	0012.a990.2241	Local	-- VI3	--	
192.168.0.1	0012.a990.2241	Local	-- Gi2/3/2	--	

ARP

IP Address	IP
MAC Address	IP
Type	ARP
Age	ARP
Interface	IP
Port	ARP

	-	-
	10.4	10.4

### 19.3.5 show arp timeout

ARP

> ~~Enter IP Address of the VR by No. G6b?..~~ ~~Enter IP Address of the~~

## 19.3.6 show ip arp

### ARP

**show ip arp**

-	-

└───┘

└───┘

└───┘

### show ip arp

Ruijie# **show ip arp**

```

Protocol Address      Age(min)Hardware      Type
Interface
Internet 192.168.7.233    23    0007.e9d9.0488    ARPA FastEthernet 0/0
Internet 192.168.7.112   10    0050.eb08.6617    ARPA FastEthernet 0/0
Internet 192.168.7.79    12    00d0.f808.3d5c    ARPA FastEthernet 0/0
Internet 192.168.7.1     50    00d0.f84e.1c7f    ARPA FastEthernet 0/0
Internet 192.168.7.215   36    00d0.f80d.1090    ARPA FastEthernet 0/0
Internet 192.168.7.127   0     0060.97bd.ebee    ARPA FastEthernet 0/0
Internet 192.168.7.195   57    0060.97bd.ef2d    ARPA FastEthernet 0/0
Internet 192.168.7.183   --    00d0.f8fb.108b    ARPA FastEthernet 0/0

```

### ARP

Protocol	Internet
Address	IP
Age (min)	ARP “_”
Hardware	IP
Type	ARPA
Interface	IP

-	-

┌

-	-

### 19.3.7 show ip interface

IP

**show ip interface** [ *interface-type interface-number* ]

<i>Interface-type</i>	
<i>Interface-number</i>	

┌

┌

```

RGOS                RGOS                RGOS
                    UP                    UP
                    UP                    UP
    
```

```

show ip interface
Ruijie# show ip interface FastEthernet 0/1
IP interface state is: UP
IP interface type is: BROADCAST
IP interface metric is: 0
IP interface MTU is: 1500
IP address is:
192.168.5.133/24 (primary)
IP address negotiate is: OFF
    
```

Forward direct-boardcast is: ON  
 ICMP mask reply is: ON  
 Send ICMP redirect is: ON  
 Send ICMP unreachableled is: ON  
 DHCP relay is: OFF  
 Fast switch is: ON  
 Route horizontal-split is: ON  
 Help address is: 0.0.0.0  
 Proxy ARP is: ON  
 Outgoing access list is not set.  
 Inbound access list is not set.

IP interface state is:	"UP"
IP interface type is:	
IP interface MTU is:	MTU
IP address is:	IP
IP address negotiate is:	IP
Forward direct-boardcast is:	
ICMP mask reply is:	ICMP
Send ICMP redirect is:	ICMP
Send ICMP unreachableled is:	ICMP
DHCP relay is:	DHCP
Fast switch is:	IP
Route horizontal-split is:	
Help address is:	helper IP
Proxy ARP is:	ARP
Outgoing access list is	
Inbound access list is	

|

|

-	-

### 19.3.8 show ip redirects

**show ip redirects**

|

-	-

|

|

|

|

**show ip redirects**

Ruijie# **show ip redirects**

Default Gateway: 192.168.195.1

|

<b>ip default-gateway</b>	

|

|

-	-

## 19.4

### 19.4.1 ip default-gateway

**ip default-gateway**                      no

**ip default-gateway**

**no ip default-gateway**

	-	-

|

|

|

**show ip redirects**

|

192.168.1.1

ip default-gateway 192.168.1.1

|

	<b>show ip redirects</b>	

|

|

	-	-

## 20 DHCP Relay

### 20.1

#### 20.1.1 ip dhcp relay check server-id

```
DHCP Relay    check server-id          no
DHCP Relay    check server-id
```

[no] ip dhcp relay check server-id

-	-

└───

└───

```

DHCP Relay    DHCP    option server-id
DHCP          DHCP    DHCP

```

```

DHCP relay    check server-id

```

```
Ruijie# configure terminal
```

```
Ruijie(config)# ip dhcp relay check server-id
```

<b>Service dhcp</b>	DHCP

└───

-	-

#### 20.1.2 ip dhcp relay information option dot1x

DHCP Relay option dot1x no

**[no] ip dhcp relay information option dot1x**

-	-

└───

└───

└───

DHCP 802.1x

└───  
 Ruijie# **configure terminal**  
 Ruijie(config)# **ip dhcp relay information option dot1x**

<b>service dhcp</b>	DHCP
<b>ip dhcp relay information option dot1x</b> <b>access-group <i>acl-name</i></b>	option dot1x acl

└───

-	-

**20.1.3 ip dhcp relay information option dot1x access-group**

DHCP Relay option dot1x ACL no  
 DHCP Relay option dot1x ACL

**[no] ip dhcp relay information option dot1x access-group *acl-name***

-	-

└───

ACL

|

---

|

---

ACL

ACL ACE

dhcp option dot1x acl

Ruijie# **configure terminal**

	<b>ip dhcp relay information option dot1x</b>	DHCP option dot1x
	-	-

### 20.1.4 ip dhcp relay information option82

DHCP Relay option82 no

[no] ip dhcp relay information option82

	-	-

option dot1x

DHCP option82

Ruijie# **configure terminal**

Ruijie(config)# **Ip dhcp relay information option82**

	<b>Service dhcp</b>	DHCP
	<b>ip dhcp relay information option dot1x</b>	DHCP option dot1x

	-	-

### 20.1.5 ip dhcp relay information option vpn

DHCP Relay  
no

DHCP Relay Aware VRF





1		192.168.1.1
2	vrf	dep1

L

L

-	-

# 21 DNS

## 21.1

### 21.1.1 ip domain-lookup

	DNS	no	DNS
	<b>ip domain-lookup</b>		
	<b>no ip domain-lookup</b>		
	-		-
	DNS		
	DNS		DNS
	DNS		
	Ruijie(config)# <b>ip domain-lookup</b>		
	<b>show hosts</b>		DNS
	-		-

### 21.1.2 ip name-server

no IP/IPv6



	<i>ip-address</i>	IP
	<b>no ip host host-name ip-address</b>	
	Ruijie(config)# <b>ip host switch 192.168.5.243</b>	
	<b>show hosts</b>	DNS
	-	-

### 21.1.4 ipv6 host

	IPV6	no
	<b>ipv6 host host-name ipv6-address</b>	
	<b>no ipv6 host host-name ipv6-address</b>	
	<i>host-name</i>	
	<i>ipv6-address</i>	IPV6
	<b>no ipv6 host host-name ipv6-address</b>	
	Ruijie(config)# <b>ipv6 host ruijie 2001:0DB8:700:20:1::12</b>	

<b>show hosts</b>	DNS

┌

-	-

## 21.2

### 21.2.1 clear host

**clear host** [*host-name*]

<i>host-name</i>	(((**)))

┌

┌

2      DNS	1      ip host    ipv6 host DNS

┌

clear host \*      -IP

<b>show hosts</b>	

┌

-	-

## 21.2.2 show hosts

DNS

**show hosts** [*hostname*]

-	-

└───┘

└───┘

└───┘

DNS

```
Ruijie# show hosts
```

```
Name servers are:
```

```
static
```

```
host          type          address
```

```
switch        static        192.168.5.243
```

```
www.ruijie.com dynamic      192.168.5.123
```

<b>ip host</b>	IP
<b>ipv6 host</b>	IPV6
<b>ip name-server</b>	DNS

└───┘

-	-

## 22 SNTP

### 22.1

#### 22.1.1 sntp enable

	SNTP	no	—Disable
<b>[no] sntp enable</b>			
	-	-	
	SNTP	Disable	
	<b>show sntp</b>	SNTP	
	Ruijie(config)# <b>sntp enable</b>		



|  
|

|

**show sntp**          SNTP

|

Ruijie(config)# **sntp server** 192.168.4.12

|

<b>show sntp</b>	SNTP

|

SNTP

---

SNTP sync interval : 60  
Time zone : +8

<b>sntp enable</b>	SNTP
<b>show sntp</b>	SNTP

RGOS10.0

-	-

# 23 NTP

## 23.1 NTP

### 23.1.1 no ntp

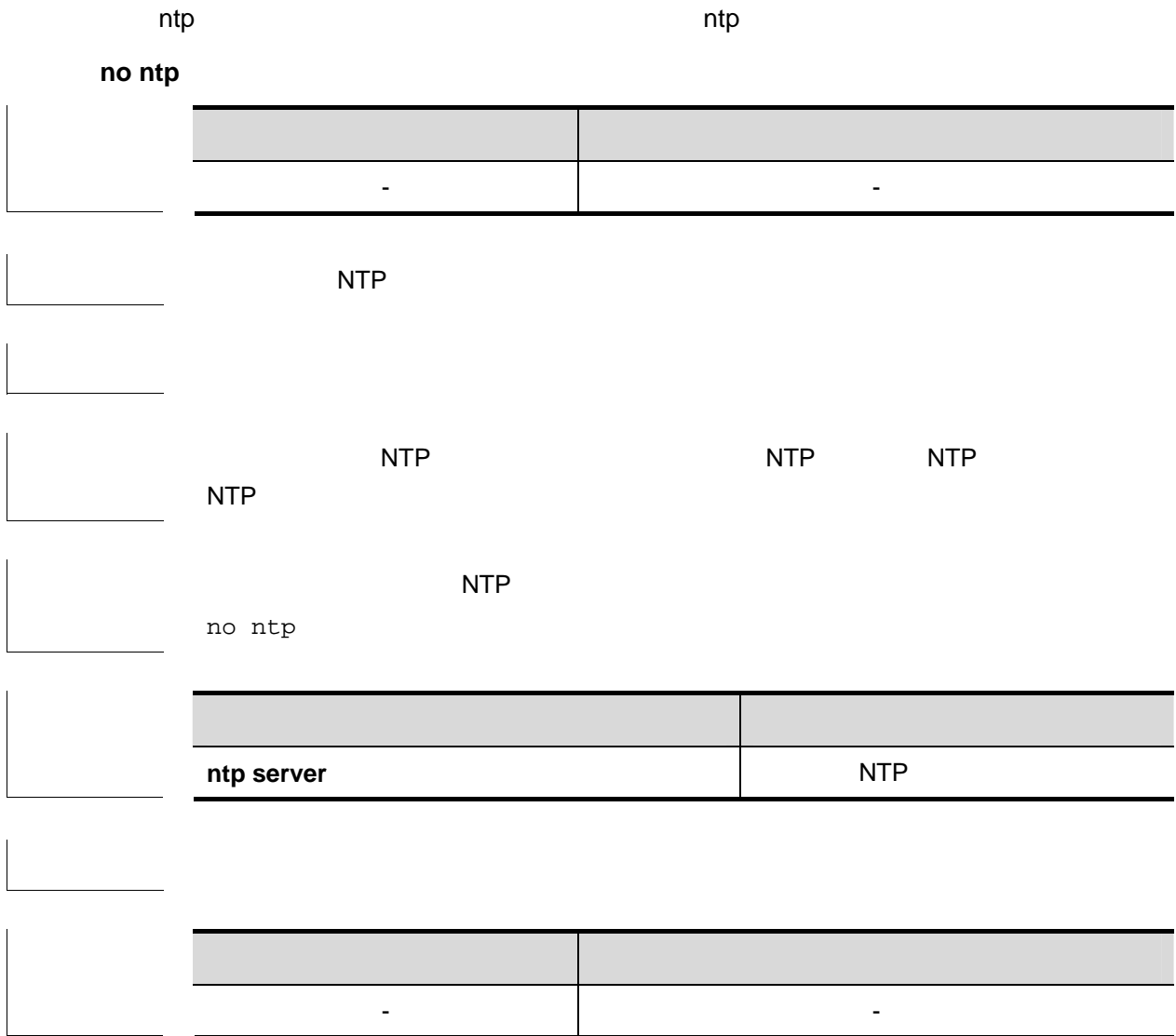

### 23.1.2 ntp access-group

NTP
no

**ntp access-group** { **peer** | **serve** | **serve-only** | **query-only** } *access-list-number* | *access-list-name*

**no ntp access-group**{**peer** | **serve** | **serve-only** | **query-only**}*access-list-number* | *access-list-name*

<b>peer</b>	NTP
<b>serve</b>	NTP
<b>serve-only</b>	NTP
<b>query-only</b>	NTP
<i>access-list-number</i>	IP 1 99 1300 1999
<i>access-list-name</i>	IP

NTP

NTP  
NTP  
NTP

peer serve serve-only query-only



1  
2

Ruijie(config)# **ntp access-group peer 1**

Ruijie(config)# **ntp access-group serve-only 2**

<b>ip access-list</b>	IP

	-	-

### 23.1.3 ntp authenticate

NTP            NTP

**ntp authenticate**

**no ntp authenticate**

	-	-

NTP

**ntp authentication-key   ntp trusted-key**

```
ntp authentication-key 6 md5 woooooop
ntp trusted-key 6
ntp authenticate
```

	<b>ntp authentication-key</b>	
	<b>ntp trusted-key</b>	

	-	-

### 23.1.4 ntp authentication-key

NTP

NTP

**ntp authentication-key** *key-id* **md5** *key-string* [*enc-type*]**no ntp authentication-key** *key-id* **md5** *key-string* [*enc-type*]

<i>key-id</i>	ID
<i>key-string</i>	
<i>enc-type</i>	0

NTP

---

	-	-
--	---	---

---

<1879153861C4]T/T1 1 Tf-2.9940 Td( )TET60.84 7404.5 0.24 20.43 ref66.84 7404.5 063.2 0 24



┌

┌

20

prefer

NTP

IP

NTP

┌

NTP server

IPv4 Ruijie(config)# **ntp server** 192.168.210.222

IPv6 Ruijie(config)# **ntp server** 10::2

┌

<b>no ntp</b>	NTP

┌

┌

-	-

### 23.1.8 ntp synchronize

NTP

**ntp synchronize**

**no ntp synchronize**

┌

-	-

┌

┌

NTP

┌

┌

NTP

Ntp synchronize

┌

ntp server	NTP

┌

┌

-	-

### 23.1.9 ntp trusted-key

ID

**ntp trusted-key** *key-id*

**no ntp trusted-key** *key-id*

┌

<i>key-id</i>	ID

┌

┌

┌

NTP

ID

┌

```
ntp authentication-key 6 md5 woooooop
ntp trusted-key 6
ntp server 192.168.210.222 key 6
```

┌

--	--



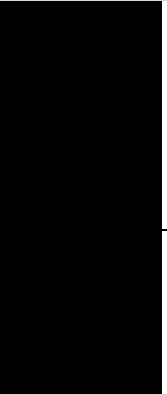
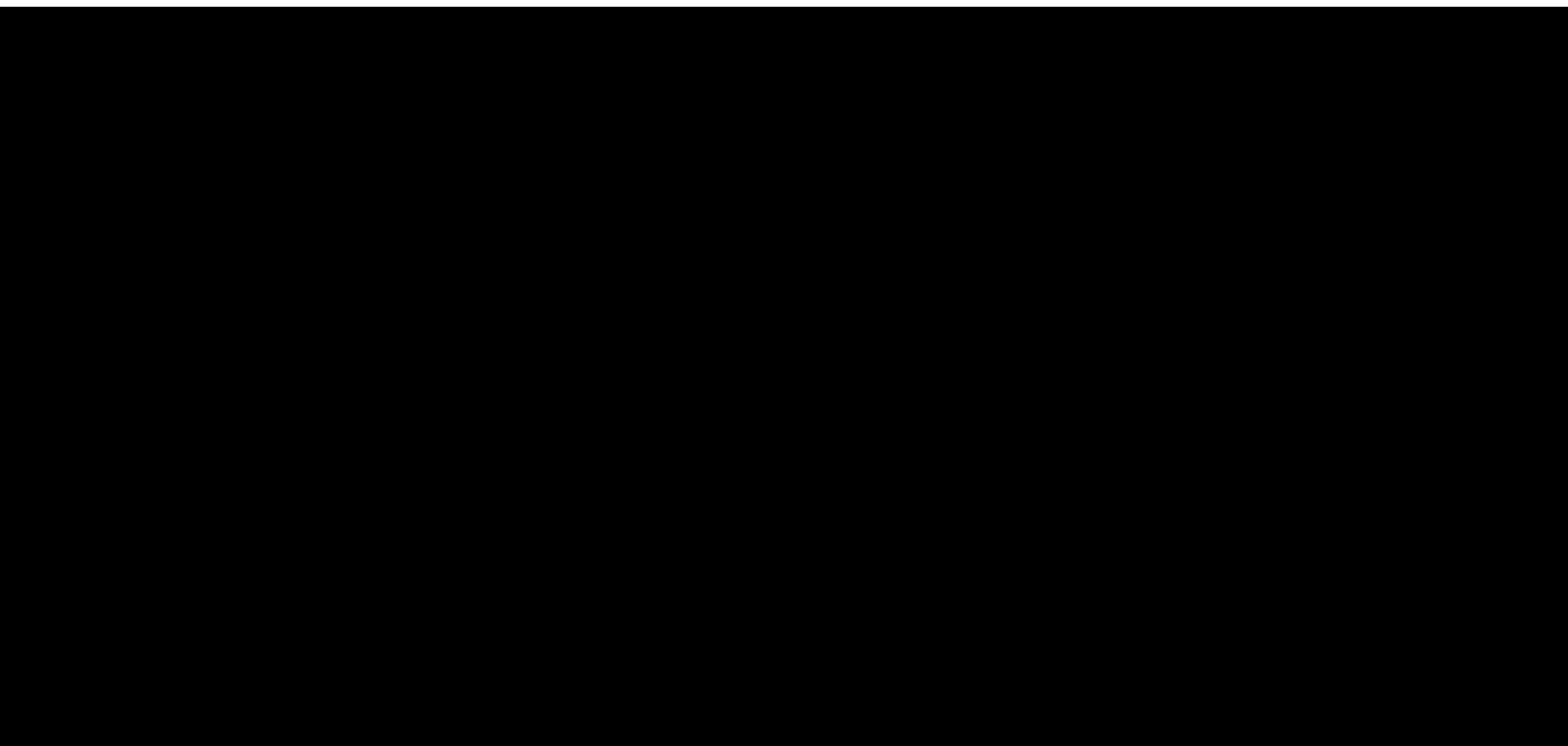

NTP

---

	-	-

|

|

|

NTP

NTP

|

NTP

show ntp status

	-	-

|

	-	-

# 24 FTP Server

## 24.1

### 24.1.1 debug ftpserver

FTP

no

**debug ftpserver**

**no debug ftpserver**



	-	-
--	---	---

### 24.1.2 ftp-server enable

FTP    no    FTP

**ftp-server enable**

**no ftp-server enable**

	-	-

--

--

	FTP	FTP	
	⚡	<b>ftp-server topdir</b>	FTP
	FTP		

1

FTP

syslog

**ftp-server password** [*type*] *password*

**no ftp-server password**

<i>type</i>	0 7 0
<i>password</i>	7

┌

┌

FTP

	1	25	4
	52		
⚡	FTP		

```

1 pass
Ruijie(config)# ftp-server password pass

Ruijie(config)# ftp-server password 0 pass
2 8001
Ruijie(config)# ftp-server password 7 8001
3
Ruijie(config)# no ftp-server password
    
```

-	-

┌

-	-

## 24.1.4 ftp-server topdir

FTP

no

FTP

**ftp-server topdir** *directory*

**no ftp-server topdir**

<i>directory</i>	FTP

FTP





FTP

```
>
>
>
>
>
>
>
>
```

FTP

```
Ruijie# show ftp-server
ftp-server information
=====
enable : Y
topdir : /
timeout: 20min
username config : Y
password config : Y
type: BINARY
control connect : Y
ftp-server: ip=192.167.201.245 port=21
ftp-client: ip=192.167.201.82 port=4978
port data connect : Y
ftp-server: ip=192.167.201.245 port=22
ftp-client: ip=192.167.201.82 port=4982
passive data connect : N
```

-	-

SNMP

SNMP

no snmp

123456:

over chassis-id 123456

	SNMP

---

<i>aclnumber</i>	1-99 MIB ipv4 NMS
<i>aclname</i>	MIB ipv4 NMS
<i>ipv6_aclname</i>	ipv6 MIB ipv6 NMMIB888

<i>text</i>	

|

|

|

SNMP

i-net800@i-net.com.cn

Ruijie(config)# **snmp-server contact**



	<i>ipv6_aclname</i>	ipv6 MIB    ipv6 NMS
--	---------------------	-------------------------

---

<i>port-num</i>	snmp
<i>notification-type</i>	snmp

SNMP

```

snmp-server enable traps NMS
SNMP
vrf [ vrf ]
    
```

```

SNMP SNMP
Ruijie(config)# snmp-server host 192.168.12.219 public snmp
    
```

<b>snmp-server enable traps</b>	

-	-

### 25.1.8 snmp-server location

```

SNMP snmp-server location no
SNMP
snmp-server location text
no snmp-server location
    
```

<i>text</i>	

|

|

|

Ruijie(config)# **snmp-server location** start-technology-city 4F of A Buliding

|

<b>snmp-sever contact</b>	SNMP

|

|

-	-

### 25.1.9 snmp-server packetsiz

SNMP  
no

**snmp-sever packetsize**

**snmp-server packetsize** *byte-count*

**no snmp-server packetsize**

|

<i>byte-count</i>	484      17876

|

1500

|

|

|

SNMP                      1492

Ruijie(config)# **snmp-server packetsize** 1492

|

--	--

	<b>snmp-server queue-length</b>	SNMP
	-	-

SNMP

no

SNMP

**snmp-server system-shutdown**

**snmp-server system-shutdown**

**no snmp-server system-shutdown**

-	-

SNMP

SNMP

RGOS

reload/reboot

NMS

SNMP

Ruijie(config)# **snmp-server system-shutdown**

-	-

-	-

### 25.1.12 snmp-server trap-source

SNMP

**snmp-server trap-source**

no

**snmp-server trap-source** *interface*

**no snmp-server trap-source**

<i>interface</i>	SNMP

SNMP

IP

┌

┌

SNMP

IP  
IP SNMP

┌

0 IP SNMP

Ruijie(config)# **snmp-server trap-source fastethernet 0**

┌

<b>snmp-server enable traps</b>	
<b>snmp-server enable host</b>	NMS

┌

┌

-	-

### 25.1.13 snmp-server trap-timeout

no

**snmp-server trap-timeout**

**snmp-server trap-timeout** *seconds*

**no snmp-server trap-timeout**

┌

seconds	1 – 1000

┌

30

┌

┌

┌

60

Ruijie(config)# **snmp-server trap-timeout 60**

<b>snmp-server queue-length</b>	
<b>snmp-server enable host</b>	NMS

┌

-	-

## 25.1.14 snmp-server user

SNMP **snmp-server user** no

**snmp-server user** *username groupname* {**v1** | **v2** | **v3** [**encrypted**] [**auth** {**md5** | **sha**} *auth-password* ] [**priv** **des56** *priv-password*]}[**access** {[**ipv6** **ipv6\_aclname** ] [**aclnum** | **aclname**]}]

**no snmp-server user** *username groupname* {**v1** | **v2c** | **v3** }

<i>username</i>			
<i>groupname</i>			
<b>v1</b>   <b>v2</b>   <b>v3</b>	SNMP	v3	
			16
<b>encrypted</b>	16	SHA	MD5
			20
<b>auth</b>			

SHA

<i>aclnum</i>	MIB ipv4 NMS
<i>aclname</i>	MIB ipv4 NMS
<i>ipv6_aclname</i>	ipv6 MIB ipv6 NMS

└──

└──

└──

```

                                snmpV3          md5          DES
Ruijie(config)# snmp-server user user-2 mib2user v3 auth md5
authpassstr priv des56 despassstr
    
```

<b>show snmp user</b>	SNMP

└──

-	-

### 25.1.15 snmp-server view

SNMP

snmp-server view

s

n

|

default

MIB

|

|

|

MIB-2 oid 1.3.6.1

Ruijie(config)# **snmp-server view mib2 1.3.6.1 include**

|

<b>show snmp view</b>	SNMP

|

|

-	-

### 25.1.16 snmp trap link-status

## 25.2

### 25.2.1 show snmp

SNMP

show snmp

**show snmp [mib | user | view | group| host]**

|

-	-

|

|

|

**show snmp**

SNMP

```

show snmp mib                snmp mib
show snmp user             snmp
show snmp view            snmp
show snmp group          snmp
show snmp host

```

SNMP

```

Ruijie# show snmp
Chassis: 60FF60
0 SNMP packets input
0 Bad SNMP version errors
0 Unknown community name
0 Illegal operation for community name supplied
0 Encoding errors
0 Number of requested variables
0 Number of altered variables
0 Get-request PDUs
0 Get-next PDUs
0 Set-request PDUs
0 SNMP packets output
0 Too big errors (Maximum packet size 1500)
0 No such name errors
0 Bad values errors
0 General errors
0 Response PDUs
0 Trap PDUs
SNMP global trap: disabled
SNMP logging: disabled
SNMP agent: enabled

```

<b>snmp-server chassis-id</b>	SNMP

-	-

# 26 RMON

## 26.1

### 26.1.1 rmon alarm

MIB no

**rmon alarm** *number variable interval {absolute | delta } rising-threshold value [event-number] falling-threshold value [event-number] [owner ownname]*

**no rmon alarm** *number*

-	-

┌

┌

RGOS variable  
 absolute/delta owner interval rising-threshold/falling-threshold event

MIB ifInNUcastPkts.6  
 Ruijie(config)# **rmon alarm** 10 1.3.6.1.2.1.2.2.1.12.6 30 **delta**  
**rising-threshold** 20 1 **falling-threshold** 10 1 **owner** zhangsan

<b>rmon event</b> <i>number [log] [trap community] [description-string]</i>	

┌

-	-

## 26.1.2 rmon collection history

**no**

**rmon collection history** *index* [**owner** *ownername*] [**buckets** *bucket-number*] [**interval** *seconds*]

**no rmon collection history** *index*



	-	-

└───

└───

└───



trap

Ruijie(config)# **rmon event**

Event type : log-and-trap  
Community : public  
Last time sent : 0d:0h:0m:0s  
Owner : zhangsan  
Log : 1  
Log time : 0d:0h:37m:47s

```
Ruijie# show rmon event
Alarm : 1
Interval : 1
Variable : 1.3.6.1.2.1.4.2.0
Sample type : absolute
Last value : 64
Startup alarm : 3
Rising threshold : 10
Falling threshold : 22
Rising event : 0
Falling event : 0
Owner : zhangsan
```

---

--	--

**rmon event** *number* [**log**] [

```

Ruijie# show rmon history
Entry : 1
Data source : Gil/1
Buckets requested : 65535
Buckets granted : 10
Interval : 1
Owner : zhangsan
Sample : 198
Interval start : 0d:0h:15m:0s
DropEvents : 0
Octets : 67988
Pkts : 726
BroadcastPkts : 502
MulticastPkts : 189
CRCAlignErrors : 0
UndersizePkts : 0
OversizePkts : 0
Fragments : 0
Jabbers : 0
Collisions : 0
Utilization : 0
    
```

<b>rmon collection history</b> <i>index</i> [owner ownername] [buckets bucket-number] [interval seconds]	

-	-

|  
 |  
 |  
 |

```

Ruijie# show rmon statistics
Statistics : 1
Data source : Gil/1
DropEvents : 0
Octets : 1884085
Pkts : 3096
BroadcastPkts : 161
MulticastPkts : 97
CRCAlignErrors : 0
UndersizePkts : 0
OversizePkts : 1200
Fragments : 0
Jabbers : 0
Collisions : 0
Pkts64Octets : 128
Pkts65to127Octets : 336
Pkts128to255Octets : 229
Pkts256to511Octets : 3
Pkts512to1023Octets : 0
Pkts1024to1518Octets : 1200
Owner : zhangsan
  
```

|  
 |  
 |

<b>rmon collection stats</b> <i>index</i> [owner <i>owner-string</i> ]	

	-	-

# 27 IPv6

## 27.1

### 27.1.1 ping ipv6

IPV6

ping ipv6 [ipv6-address]

ipv6-addres	s

└───┘

└───┘

└───┘

└───┘

Ruijie# ping ipv6 fec0::1

ping

!	
.	
U	
R	
F	
A	
D	Down
?	IPV6 ( )

└───┘

-	-

┌

┌

-	-

### 27.1.2 ipv6 address

IPV6 , no

**ipv6 address** *ipv6-address/prefix-length*

**ipv6 address** *ipv6-prefix/prefix-length eui-64*

**ipv6 address** *prefix-name sub-bits/prefix-length [eui-64]*

**no ipv6 address**

**no ipv6 address** *ipv6-address/prefix-length*

**no ipv6 address** *ipv6-prefix/prefix-length eui-64*

**no ipv6 address** *prefix-name sub-bits/prefix-length [eui-64]*

┌

┌

┌

<i>ipv6-address</i>	IPV6 RFC4291 16
<i>ipv6-prefix</i>	IPV6 RFC4291 16
<i>prefix-length</i>	IPV6 IPV6
<i>prefix-name</i>	
<i>sub-bits</i>	RFC4291
<b>eui-64</b>	IPV6 64 ID

┌

┌

IPV6		UP			
	IPv6		IPv6	=	+
	+		<b>ipv6 general-prefix</b>		
DHCPv6		PD		DHCPv6	
	+		<i>sub-bits/prefix-length</i>		
<b>no ipv6 address</b>					

|



**default**

2	IPv6	<b>ipv6 enable</b>
	IPv6	
	IPv6	IPv6
	<b>no ipv6 enable</b>	IPV6

Ruijie(config-if)# **ipv6 enable**

<b>show ipv6 interface</b>	
----------------------------	--

-	-
---	---

### 27.1.5 ipv6 general-prefix

IPv6

**ipv6 general-prefix**

**ipv6 general-prefix** *prefix-name ipv6-prefix/prefix-length*

**no ipv6 general-prefix** *prefix-name ipv6-prefix/prefix-length*

<i>prefix-name</i>	
<i>ipv6-prefix</i>	RFC4291
<i>prefix-length</i>	

IPv6

my-prefix

Ruijie(config)# **ipv6 general-prefix** my-prefix 2001:1111:2222::/48

<b>ipv6 address</b> prefix-name	
sub-bits/prefix-length	
<b>show ipv6 general-prefix</b>	

RGOS10.4	RGOS10.4

### 27.1.6 ipv6 hop-limit

**ipv6 hop-limit value**

**no ipv6 hop-limit**

-	-

64

Ruijie(config)# **ipv6 hop-limit** 100

--	--

	-	-
	-	-

### 27.1.7 ipv6 nd dad attempts

```

                IPV6                                (NS)
                no
    ipv6 nd dad attempts value
    no ipv6 nd dad attempts
    
```

value	(NS)	0
	0-600	ipv6 :

```

1

```

```

                IPV6
                "tentative"( )
                EUI-64
                (                IPV6                )
                down/up
                down                up
    
```

```

Ruijie(config)# interface vlan 1
Ruijie(config-if)# ipv6 nd dad attempts 3
    
```

<b>show ipv6 interface</b>	

IPv6

no

**ipv6 neighbor** *ipv6-address interface-id hardware-address*

**no ipv6 neighbor** *ipv6-address interface-id*

<i>ipv6-address</i>	IPV6	RFC4291
<i>interface-id</i>	SVI	Routed Port,L3 AP
<i>hardware-address</i>	MAC	XXXX.XXXX.XXXX 48 'X'

[ ]

[ ]

ARP

IPV6

NDP

Reachble

IPV6

mac

inactive

show ipv6 neighbor static

**clear ipv6 neighbors** ( NDP)

**show ipv6 neighbors**

Ruijie(conifg)# **ipv6 neighbor** 2001::1 vlan 1 00d0.f811.1111

<b>show ipv6 neighbors</b>	
<b>clear ipv6 neighbors</b>	

[ ]

[ ]

-	-
---	---

### 27.1.10 ipv6 ns-linklocal-src

**no ipv6**  
IPv6

**ns-linklocal-src**  
RFC3484

**ipv6 ns-linklocal-src**

**no ipv6 ns-linklocal-src**

-	-

|

|

|

|

Ruijie(config)# **no ipv6 ns-linklocal-src**

-	-

|

-	-

### 27.1.11 ipv6 route

IPV6

no

**ipv6 route** *ipv6-prefix/prefix-length* {*ipv6-address* | *interface-id* [*ipv6-address*]}

**no ipv6 route** *ipv6-prefix/prefix-length* {*ipv6-address* | *interface-id* [*ipv6-address*]}

<i>ipv6-prefix</i>	IPV6 RFC4291
<i>prefix-length</i>	IPV6 '/'

<i>ipv6-address</i>	RFC4291
<i>interface-id</i>	

┌

┌

\_\_\_\_\_

⚡

\_\_\_\_\_

┌

Ruijie(config)# **ipv6 route 2001::/64 vlan 1 2005::1**

┌

<b>show ipv6 route</b>	IPv6

┌

┌

-	-

### 27.1.12 ipv6 source-route

	IPv6	no
IPv6		
<b>ipv6 source-route</b>		
<b>no ipv6 source-route</b>		

	-	-

|

IPv6

|

|

0

IPv6

0

IPv6

|

Ruijie(config)# **no ipv6 source-route**

|

	-	-

## 27.2

### 27.2.1 clear ipv6 neighbors

**clear ipv6 neighbors**

	-	-

┌

┌

┌

Ruijie# **clear ipv6 neighbors**

	<b>ipv6 neighbor</b>	
	<b>show ipv6 neighbors</b>	

┌

	-	-

### 27.2.2 show ipv6 general-prefix

**show ipv6 general-prefix**

**show ipv6 general-prefix**

	-	-



```

Ruijie# show ipv6 interface vlan 1
Interface vlan 1 is Up, ifindex: 2001
address(es):
Mac Address: 00:00:00:00:00:01
INET6: fe80::200:ff:fe00:1 , subnet is fe80::/64
INET6: 2001::1 , subnet is 2001::/64 [TENTATIVE]
Joined group address(es):
ff01:1::1
ff02:1::1
ff02:1::2
ff02:1::1:ff00:1
MTU is 1500 bytes
ICMP error messages limited to one every 10 milliseconds
ICMP redirects are enabled
ND DAD is enabled, number of DAD attempts: 1
ND reachable time is 30000 milliseconds
ND advertised reachable time is 0 milliseconds
ND retransmit interval is 1000 milliseconds
ND advertised retransmit interval is 0 milliseconds
ND router advertisements are sent every 200 seconds<240--160>
ND router advertisements live for 1800 seconds

```

INET6: 2001::1 , subnet is 2001::/64

[TENTATIVE]	INET6	[ ]
ANYCAST		
TENTATIVE		(DAD)
DUPLICATED		
DEPRECATED		
NODAD		
AUTOIFID		EUI-64
PRE		
GEN		

```
Ruijie# show ipv6 interface vlan 1 ra-info
```

vlan 1: DOWN

total	
fec0:1:1:1::/64	
Def	
Auto   CFG	Auto IPV6 , CFG
!Adv	
vtime	( )
ptime	( )
L   !L	L !L on-link
A   !A	A

1 SVI 1

Ruijie# **show ipv6 neighbors vlan 1**

```
IPv6 Address Linklayer Addr Interface
fa::1          00d0.0000.0002 vlan 1
fe80::200:ff:fe00:2 00d0.0000.0002 vlan 1
```

2

Ruijie# **show ipv6 neighbors verbose**

```
IPv6 Address Linklayer Addr Interface
2001::1       00d0.f800.0001 vlan 1
                State: Reach/H Age: - asked: 0
fe80::200:ff:fe00:1 00d0.f800.0001 vlan 1
                State: Reach/H Age: - asked: 0
```

IPv6 Address	IPV6
Linklayer Addr	Mac incomplete
Interface	

```

state/H(R)
STATE
INCMP( Incomplete)—
      (NS)
      (NA)
REACH(Reachable) —

      STALE —

NUD
( Neighbor Unreachability Detection )
DELAY—          STALE
                STALE    DELAY
State           DELAY_FIRST_PROBE_TIME seconds(5  )

      DELAY      PROBE
                (NS)      NUD
PROBE—      NUD
      RetransTimer milliseconds
      (NS)

MAX_UNICAST_SOLICIT(3  )
?—
/R—

```

## Interface

G Q,Á/P Yb Q V@ldr Q )b Sc“hG /Q`Ab •a-a ðÀ R T

**show ipv6 router**

IPv6

Ruijie# **show ipv6 router**

Router FE80::2D0:F8FF:FEC1:C6E1 on VLAN 2, last update 62 sec  
Hops 64, Lifetime 1800 sec, ManagedFlag=0, OtherFlag=0, MTU=1500  
Preference=MEDIUM  
Reachable time 0 msec, Retransmit time 0 msec  
Prefix 6001:3::/64 onlink autoconfig  
Valid lifetime 2592000 sec, preferred lifetime 604800 sec  
Prefix 6001:2::/64 onlink autoconfig  
Valid lifetime 2592000 sec, preferred lifetime 604800 sec

-	-



# 28 MLD Snooping

## 28.1

### 28.1.1 ipv6 mld profile

MLD profile profile profile-number mld  
profile

	<b>10.4</b>	

### 28.1.3 deny

	profile	profile	deny
	<b>deny</b>		
	profile	deny	
	profile		
	profile	range	
		FF77::100	profile :
	Ruijie(config)# <b>ipv6 mld profile 1</b>		
	Ruijie(config-profile)# <b>range FF77::100</b>		
	Ruijie(config-profile)# <b>deny</b>		
	ipv6 mld profile	profile	
	range		
	permit	profile	permit
	<b>10.4</b>		

### 28.1.4 permit

	profile	profile	permit
	<b>permit</b>		



┌

┌

┌

┌

┌

	VLAN		VLAN	VLAN
	VLAN		VLAN	
		mld snooping	ivgl	
	Ruijie(config)# <b>ipv6 mld snooping ivgl</b>			
	<b>ipv6 mld snooping svgl</b>	mld snooping	svgl	
	<b>ipv6 mld snooping ivgl-svgl</b>	mld snooping		
	<b>10.4</b>			

### 28.1.6 ipv6 mld snooping dyn-mr-aging-time

**ipv6 mld snooping dyn-mr-aging-time *time***  
**no ipv6 mld snooping dyn-mr-aging-time**

**ipv6 mld snooping dyn-mr-aging-time *time***  
**no ipv6 mld snooping dyn-mr-aging-time**

┌

┌

┌

┌

┌

<i>time</i>			1-3600
300s			
Hello		MLD	IPv6 PIM
		500s	

Ruijie(config)# **ipv6 mld snooping dyn-mr-aging-time 500**

--	--



MLD query PIM  
**ipv6 mld snooping vlan mrouter learn** no

**ipv6 mld snooping vlan *vid* mrouter learn**  
**no ipv6 mld snooping vlan *vid* mrouter learn**

<i>vid</i>	vlan	id	1-4094

VLAN

**ipv6 mld snooping vlan *vid* mrouter interface *interface-id***

<i>vid</i>	vlan id	1-4094
<i>ipv6-multiaddr</i>		
<i>interface-id</i>		

└───┘

└───┘

└───┘

```

                                FF88::1
Ruijie(config)# ipv6 mld snooping vlan 1 static FF88::1 interface
fastEthernet 0/1
    
```

<b>ipv6 mld snooping vlan mrouter interface</b>	

└───┘

<b>10.4</b>	

### 28.1.12 ipv6 mld snooping fast-leave enable

```

                                mld snooping fast-leave          ipv6 mld snooping
fast-leave enable                no                mld snooping fast-leave

ipv6 mld snooping fast-leave enable
no ipv6 mld snooping fast-leave enable
    
```

└───┘

└───┘



```
Ruijie(config)# ipv6 mld snooping suppression
```

<b>10.4</b>	

### 28.1.14 ipv6 mld snooping filter

```
profile      no      profile
ipv6 mld snooping filter profile-number
no ipv6 mld snooping filter profile-number
```

<i>profile-num</i>	profile

MLD Profile

MLD Report

MLD Profile

profile

filter

0/1 profile 1

```
Ruijie(config)# interface fastEthernet 0/1
```

```
Ruijie(config-if)# ipv6 mld snooping filter 1
```

<b>ipv6 mld profile</b>	profile

	<b>10.4</b>	

**clear ipv6 mld snooping gda-table**

|

|

|

|

Ruijie# **clear ipv6 mld snooping gda-table**

|

10.4	

### 28.1.17 debug mld-snp

mld , debug mld-snp

**debug mld-snp**  
**undebug mld-snp**

|

|

|

|

mld

mld

```
Ruijie# debug mld-snp
```

10.4	

## 28.2

### 28.2.1 show ipv6 mld snooping

```
mld snooping
```

```
Show ipv6 mld snooping [gda-table | interfaces | mrouter/ statistics [vlan vlan-id ]
```

	mld snooping
<b>gda-table</b>	
<b>interfaces</b>	mld snooping Filtering
<b>mrouter</b>	
<b>statistics [vlan <i>vlan-id</i>]</b>	snooping

```
mld snooping
```

```
1 show ipv6 mld snooping mld snooping
```

```
Ruijie# show ipv6 mld snooping
```

```
MLD-snooping mode      : IVGL
SVGL vlan-id           : 1
SVGL profile number    : 0
Source check port      : Disabled
```

Query max response time : 10(Seconds)

2        **show ipv6 mld snooping statistics**                    mld snooping

Ruijie# **show ipv6 mld snooping statistics**

GROUP	Interface	Last report time	Last leave time	Last reporter
FF88::1	VL1:Gi4/2	0d:0h:0m:7s	----	2003::1111
		Report pkts: 1		Leave pkts: 0

3        **show ipv6 mld snooping mrouter**                    mld snooping

Ruijie# **show ipv6 mld snooping mrouter**

Vlan	Interface	State	MLD profile number
1	GigabitEthernet 0/7	static	1
1	GigabitEthernet 0/12	dynamic	0

4        **show ipv6 mld snooping gda-table**                    GDA

Ruijie# **show ipv6 mld snooping gda-table**

Abbr: M - mrouter

      D - dynamic

      S - static

VLAN	Address	Member ports
1	FF88::1	GigabitEthernet 0/7(S)

5

10.4

## 28.2.2 show ipv6 mld profile

MLD profile

**show ipv6 mld profile** [*profile-number*]

	profile
<i>profile-number</i>	profile

mld profile

```

1      show ipv6 mld profile      MLD profile
Ruijie# show ipv6 mld profile 1
MLD Profile 1
permit
range FF77::1 FF77::100
range FF88::123
    
```

10.4

---

# 29

## 29.1

### 29.1.1 storm-control

no

**storm-control** {**broadcast** | **multicast** | **unicast**} [{**level** *percent* | **pps** *packets* | *rate-bps*}]

**no storm-control** {**broadcast** | **multicast** | **unicast**} [ {**level** *percent* | **pps** *packets* | *rate-bps*}]

<b>broadcast</b>	
<b>multicast</b>	
<b>unicast</b>	
<i>percent</i>	20 20%
<i>packets</i>	pps packets per second
<i>Rate-bps</i>	
<i>64k-2M</i>	64k
<i>2-100M</i>	1M
<i>100M</i>	8M

**show storm-control**

GigabitEthernet 1/1

4M

Ruijie# **configure terminal**

Ruijie(config)# **interface GigabitEthernet 1/1**

Ruijie(config-if)# **storm-control multicast 4096**

Ruijie(config-if)# **end**

<b>show storm-control</b>	

86      **pps**

-	-

### 29.1.2 switchport protected

no

**switchport protected**

**no switchport protected**

-	-

3

**show interfaces**

Ruijie(config)# **interface gigabitethernet 1/1**

Ruijie(config-if)# **switchport protected**

<b>show interfaces</b>	

---

└───

└───

-	-

### 29.1.3 switchport port-security

no

**switchport port-security [violation {protect | restrict | shutdown}]**

**no switchport port-security [violation]**

└───

<b>port-security</b>	
<b>violation protect</b>	
<b>violation restrict</b>	trap
<b>violation shutdown</b>	Trap

└───

---

**show port-security**

---

	<b>show port-security</b>	
--	---------------------------	--

---

--	--	--

<b>switchport port-security</b>	
<b>switchport port-security binding interface</b>	
<b>Switchport port-security mac-address</b>	
<b>switchport port-security aging</b>	
<b>show port-security</b>	

-	-

### 29.1.6 switchport port-security binding interface

IP+    MAC            IP

no

**[no] switchport port-security binding interface** *interface-id* *mac-address* **vlan** *vlan\_id* *ipv4-address* | *ipv6-address*

**[no] switchport port-security binding interface** *interface-id* *ipv4-address* | *ipv6-address*

<i>interface-id</i>	ID
<i>mac-address</i>	MAC
<i>Vlan_id</i>	MAC    VID
<i>Ipv4-address</i>	Ipv4    Ip
<i>Ipv6-address</i>	Ipv6    Ip

```

1      192.168.1.100      10
Ruijie(config)# switchport port-security binding interface g0/10
192.168.1.100
2      192.168.1.100 MAC      00d0.f800.5555, VID= 1      10
Ruijie(config)# switchport port-security binding interface g0/10 00d0.f800.5555
vlan 1 192.168.1.100

```

	<b>switchport port-security</b>	
	<b>switchport port-security binding</b>	
	<b>Switchport port-security mac-address</b>	
	<b>switchport port-security aging</b>	
	<b>show port-security</b>	





---

1 TRUNK 10

---

```
1      TRUNK    10          00d0.f800.5555 VID=2
Ruijie(config)#  switchport  port-security  interface  g0/10
mac-address 00d0.f800.5555 vlan 2
```

```

Interface Broadcast Control Multicast Control Unicast Control
-----
Gi1/1 Disabled Disabled Disabled

```

<b>.storm-control</b>	

-	-

### 29.2.2 show port-security

**show port-security** [*address*] [*interface interface-id*] [*all*]

<b>address</b>	
<b>interface</b> <i>interface-id</i>	
<b>all</b>	

```

Ruijie# show port-security
Secure Port MaxSecureAddr(count) CurrentAddr(count) Security
Action
-----
Gi1/1 128 1 Restrict
Gi1/2 128 0 Restrict
Gi1/3 8 1 Protect

```

---

	<b>switchport port-security</b>	
	<b>switchport port-security aging</b>	
	<b>switchport port-security mac-address</b>	

---

	-	-

## 30 802.1X

### 30.1 dot1x

#### 30.1.1 dot1x auto-req

802.1X

dot1x auto-req

no

[no] dot1x auto-req

-	-

└───

└───

└───

802.1x

show dot1x auto-req

└───

802.1x

```

Ruijie# configure terminal
Ruijie(config)# dot1x auto-req
Ruijie(config)# end
Ruijie# show dot1x auto-req
Ruijie(config)# dot1x auto-req
Auto-Req: Enabled
User-Detect : Enabled
Packet-Num : 0
Req-Interval: 30 Second

```

└───

show dot1x auto-req	

└───



	-	-

### 30.1.3 dot1x auto-req req-interval

no

**dot1x auto-req req-interval** *interval*

**no dot1x auto-req req-interval**

	<i>interval</i>	s

30

**show dot1x auto-req**

802.1x

60s

### 30.1.4 dot1x auto-req user-detect

no

**dot1x auto-req user-detect**

**no dot1x auto-req user-detect**

-	-

└───

└───

└───

**show dot1x auto-req**

└───

```
Ruijie# configure terminal
Ruijie(config)# dot1x auto-req user-detect
Ruijie(config)# end
Ruijie# show dot1x auto-req
Auto-Req: Enabled
User-Detect : Enabled
Packet-Num : 0
Req-Interval: 60 Second
```

└───

<b>show dot1x auto-req</b>	

└───

└───

-	-

## 30.2 dot1x

### 30.2.1 dot1x timeout quiet-period

**no**

**dot1x timeout quiet-period** *seconds*

**no dot1x timeout quiet-period**

<i>seconds</i>	0 65535 s

10

**show dot1x**

```

1000s
Ruijie# configure terminal
Ruijie(config)# dot1x timeout quiet-period 1000
Ruijie(config)# end
Ruijie# show dot1x
802.1X Status:      Enabled
Authentication Mode: EAP-MD5
Authed User Number: 0
Re-authen Enabled:  Disabled
Re-authen Period:  3600 sec
Quiet Timer Period: 1000 sec
Tx Timer Period:   3 sec
Supplicant Timeout: 3 sec
Server Timeout:   5 sec
Re-authen Max:    3 times
Maximum Request:  3 times
Filter Non-RG Supp: Disabled

```

Client Oline Probe: Disabled  
Eapol Tag Enable: Disabled  
Authorization Mode: Group Server

<b>show dot1x</b>	802.1x

	-

period

seconds

Re-authen Period: 1000 sec  
Quiet Timer Period: 1000 sec  
Tx Timer Period: 3 sec  
Supplicant Timeout: 3 sec  
Server Timeout: 5 sec  
Re-authen Max: 3 times  
Maximum 2Request: 3 times  
Filter Non-RG Supp: Disabled  
Client Oline Probe: Disabled  
Eapol Tag Enable: Disabled  
Authorization Mode: Group Server







-	-
---	---

### 30.2.5 dot1x timeout tx-period

no

**dot1x timeout tx-period** *seconds*

**no dot1x timeout tx-period**

<i>seconds</i>	0 65535

3

**show dot1x** 802.1x

10s

```
Ruijie# configure terminal
Ruijie(config)# dot1x timeout tx-period 10
Ruijie(config)# end
Ruijie# show dot1x
802.1X Status:      Enabled
Authentication Mode: EAP-MD5
Authed User Number: 0
Re-authen Enabled:  Disabled
Re-authen Period:   1000 sec
Quiet Timer Period: 1000 sec
Tx Timer Period:    10 sec
Supplicant Timeout: 10 sec
Server Timeout:     10 sec
Re-authen Max:      3 times
Maximum Request:    3 times
Filter Non-RG Supp: Disabled
Client Oline Probe: Disabled
Eapol Tag Enable:   Disabled
```

Authorization Mode: Group Server



**show dot1x**

802.1x

```

Re-authen Period:    1000 sec
Quiet Timer Period:  1000 sec
Tx Timer Period:     10 sec
Supplicant Timeout:  10 sec
Server Timeout:      10 sec
Re-authen Max:       3 times
Maximum Request:     3 times
Filter Non-RG Supp:  Disabled
Client Oline Probe:  Disabled
Eapol Tag Enable:    Disabled
Authorization Mode:   Group Server

```

<b>show dot1x</b>	802.1x

-	-

### 30.3.2 dot1x reauth-max

**no**

**dot1x reauth-max** *count*

**no dot1x reauth-max**

<i>count</i>	

3

**show dot1x**

802.1x

```

Ruijie# configure terminal
Ruijie(config)# dot1x reauth-max 5
Ruijie(config)# end
Ruijie# show dot1x
802.1X Status:          Enabled
Authentication Mode:   EAP-MD5
Authenticated User Number: 0
Re-authen Enabled:    Enabled
Re-authen Period:     1000 sec
Quiet Timer Period:   1000 sec
Tx Timer Period:      10 sec
Supplicant Timeout:   10 sec
Server Timeout:       10 sec
Re-authen Max:        5 times
Maximum Request:      3 times
Filter Non-RG Supp:   Disabled
Client Oline Probe:   Disabled
Eapol Tag Enable:     Disabled
Authorization Mode:   Group Server

```

<b>show dot1x</b>	802.1x

-	-

## 30.4 dot1x

### 30.4.1 dot1x probe-timer

**dot1x probe-timer**{interval | alive}*interval*

**no dot1x probe-timer**

<b>no</b>	
<i>interval</i>	hello
<b>alive</b>	
<b>interval</b>	

```
Hello          20
                250
```

```
show dot1x      802.1x
```

```
hello          30 ,          120
Ruijie# configure terminal
Ruijie(config)# dot1x probe-timer interval 30
Ruijie(config)# dot1x probe-timer alive 120
Ruijie(config)# end
Ruijie# show dot1x probe-timer
Hello Interval: 30 Seconds
Hello Alive: 120 Seconds
```

<b>Show dot1x probe-timer</b>	
-------------------------------	--

---

	-	-
--	---	---

---

--	--	--

---

--	--	--

---

--	--	--

```
Ruijie# configure terminal
Ruijie(config)# dot1x client-probe enable
Ruijie(config)# end
Ruijie# show dot1x
802.1X Status:      Enabled
Authentication Mode: EAP-MD5
Authed User Number: 0
Re-authen Enabled:  Enabled
Re-authen Period:   1000 sec
Quiet Timer Period: 1000 sec
Tx Timer Period:    10 sec
Supplicant Timeout: 10 sec
Server Timeout:     10 sec
```

## 30.5 dot1x

### 30.5.1 dot1x authentication

AAA

AAA

**no****dot1x authentication {default | list-name}****no dot1x authentication {default | list-name}**

<b>default</b>	
<i>list-name</i>	

AAA

AAA

AAA

dot1x

group radius

```

Ruijie# configure terminal
Ruijie(config)# aaa new-model
Ruijie(config)# aaa authentication dot1x default group radius
Ruijie(config)# interface fastEthernet0/1
Ruijie(config-if)# dot1x authentication default
Ruijie(config-if)# end

```

<b>aaa new-model</b>	AAA
<b>aaa authentication dot1x</b>	

-	-
---	---

## 30.5.2 dot1x auth-address-table

802.1X

no

**dot1x auth-address-table address** *mac-addr* **interface** *interface*

**no dot1x auth-address-table address** *mac-addr* **interface** *interface*

<i>mac-addr</i>	
<i>Interface</i>	

S\*ü

table

802.1X

show dot1x auth-address

**dot1x auth-mode {eap-md5 | chap | pap}**

**no dot1x auth-mode**

<b>eap-md5</b>	802.1x	EAP-MD5
<b>chap</b>	802.1x	CHAP
<b>pap</b>	802.1x	PAP

EAP-MD5

**show dot1x** 802.1x

802.1x

```
Ruijie# configure terminal
Ruijie(config)# dot1x auth-mode chap
Ruijie(config)# end
Ruijie#
```

<b>show dot1x</b>	802.1x

```
show dot1x 802.1x
```

```
802.1x
```

```
Ruijie# configure terminal
Ruijie(config)# dot1x default
Ruijie(config)# end
Ruijie# end
```

show dot1x	802.1x
-	-

### 30.5.5 dot1x dynamic-vlan enable

vlan

no

dot1x dynamic-vlan enable

no dot1x dynamic-vlan enable

-	-

```
show dot1x dynamic-vlan 802.1x
```

```
802.1x vlan
```

```
Ruijie# configure terminal
```

```
Ruijie(config)# dot1x dynamic-vlan enable
Ruijie(config)# end
Ruijie#
```

<b>show dot1x</b>	802.1x

-	-

### 30.5.6 dot1x guest-vlan

```

      guest vlan          no
dot1x dynamic-vlan <1 - 4094>
no dot1x guest-vlan

```

vid	<1 - 4094>

```

>          guest vlan          dot1x dynamic-vlan enable
      guest vlan
>          guest vlan
      vlan
>          show running-config          802.1x

```

```

      802.1x guest vlan
Ruijie# configure terminal
Ruijie(config)# dot1x guest-vlan 10
Ruijie(config)# end
Ruijie#
```

	<b>show running-config</b>	802.1x

	-	-

### 30.5.7 dot1x eapol-tag

EAPOL TAG

**dot1x eapol-tag**

**no dot1x eapol-tag**

-	-

|

|

|

**show dot1x** 802.1x

|

802.1X tag

```
Ruijie# configure terminal
Ruijie(config)# dot1x eapol-tag
Ruijie(config)# end
Ruijie#
```

|

<b>show dot1x</b>	802.1x

|

|

-	-

### 30.5.8 dot1x max-req

DOT1X

DOT1X

DOT1X

**no**

**dot1x max-req** *count*

**no dot1x max-req**



---

**show dot1x private-supPLICANT-only**      802.1x

```
Ruijie# configure t
Ruijie(config)# dot1x private-supPLICANT-only
Ruijie(config)# end
Ruijie#
```

<b>show dot1x private-supPLICANT-only</b>	

-	-

### 30.5.10 dot1x port-control auto

**no**

**dot1x port-control auto**

**no dot1x port-control**



```
Ruijie#
```

<b>show dot1x</b>	802.1x

-	-

### 30.5.11 dot1x port-control-mode

802.1x

MAC

**dot1x port-control-mode {mac-based | {port-based [single-host]} }**

**no dot1x port-control-mode**

<b>mac-based</b>	mac 802.1X
<b>port-based</b>	802.1X
<b>single-host</b>	802.1x

```
mac-based
```

```

show dot1x port-control 802.1x
s2600 802.1X
802.1X

single-host 802.1x show dot1x port-control
port-based show running-config dot1x port-control-mode

```

**port-based single-host**

single-host

default-user-limit

single-host

---

|

|

|

|

```
802.1x
Ruijie# configure terminal
Ruijie(config)# dot1x stationarity enable
Ruijie(config)# end
Ruijie#
```

|

-	-

|

|

-	-

### 30.5.13 dot1x redirect url

```
802.1x
URL      http://
URL      https://
http://ruijie.net/web
```

|

|

```
1          ruijie.net/web
Ruijie(config)# dot1x redirect url http://ruijie.net/web
```

|



**dot1x redirect for special tcp-  
destination port**



<b>dot1x redirect url</b>	web	ip	ip
<b>dot1x redirect for special tcp-destination port</b>			
<b>dot1x redirect num for special source-ip</b>			
<b>show dot1x</b>	dot1x		

└───┘

-	-

### 30.5.16 dot1x redirect num for special source-ip

1 1-10 no

**dot1x redirect num for special source-ip *num***

**no dot1x redirect num for special source-ip**

<i>num</i>	

└───┘

1

└───┘

└───┘

```

1 3
Ruijie(config)# dot1x redirect num for special source-ip 3
    
```

<b>dot1x redirect url</b>	
<b>dot1x redirect for special tcp-destination port</b>	web
	ip ip

<b>dot1x redirect time-out</b>	
<b>show dot1x</b>	dot1x
-	-

## 30.6 dot1x

### 30.6.1 show dot1x

802.1x

**show dot1x**

-	-

```
Ruijie# show dot1x
802.1X Status:      Enabled
Authentication Mode: EAP-MD5
Authed User Number: 0
Re-authen Enabled: Disabled
Re-authen Period:  3600 sec
Quiet Timer Period: 10 sec
Tx Timer Period:   3 sec
Supplicant Timeout: 3 sec
Server Timeout:   5 sec
Re-authen Max:    3 times
```

```

Maximum Request:      3 times
Filter Non-RG Supp:  Disabled
Client Oline Probe:  Disabled
Eapol Tag Enable:    Disabled
Authorization Mode:   Group Server
Ruijie#

```

<b>dot1x auth-mode</b>	802.1x
<b>dot1x max-req</b>	
<b>dot1x port-control auto</b>	
<b>dot1x reauth-max</b>	
<b>dot1x re-authentication</b>	
<b>dot1x timeout quiet-period</b>	
<b>dot1x timeout re-authperiod</b>	
<b>dot1x timeout server-timeout</b>	
<b>dot1x timeout supp-timeout</b>	
<b>dot1x timeout tx-period</b>	

-	-

### 30.6.2 show dot1x auth-address-table

802.1X

**show dot1x auth-address-table***[addressmac-addr][interface interface]*

<i>mac-addr</i>	

*interface*

```
Ruijie# show dot1x auth-address-table
interface:g3/1
-----
mac addr: 00D0.F800.0001
Ruijie#
```

<b>dot1x auth-mode</b>	802.1x
<b>dot1x max-req</b>	
<b>dot1x port-control auto</b>	
<b>dot1x reauth-max</b>	
<b>dot1x re-authentication</b>	
<b>dot1x timeout quiet-period</b>	
<b>dot1x timeout re-authperiod</b>	
<b>dot1x timeout server-timeout</b>	
<b>dot1x timeout supp-timeout</b>	
<b>dot1x timeout tx-period</b>	

-	-

### 30.6.3 show dot1x auto-req

802.1x

show dot1x auto-req

-	-

└───┘

└───┘

└───┘

```
Ruijie# show dot1x auto-req
Auto-Req: Disabled
User-Detect : Enabled
Packet-Num : 0
Req-Interval: 30 Seconds
```

<b>dot1x auth-mode</b>	802.1x
<b>dot1x max-req</b>	
<b>dot1x port-control auto</b>	
<b>dot1x reauth-max</b>	
<b>dot1x re-authentication</b>	
<b>dot1x timeout quiet-period</b>	
<b>dot1x timeout re-authperiod</b>	
<b>dot1x timeout server-timeout</b>	
<b>dot1x timeout supp-timeout</b>	
<b>dot1x timeout tx-period</b>	

---

|

|

-	-

---

### 30.6.4 show dot1x private-supPLICANT-only

**show dot1x private-supPLICANT-only**

|

-	-

|

|

|

|

```
Ruijie# show dot1x private-supPLICANT-only
private-supPLICANT-only:: disabled
Ruijie#
```



## 30.6.5 show dot1x max-req

show dot1x max-req

-	-

└───

└───

└───

```
Ruijie# show dot1x max-req
max-req: 2 times
Ruijie#
```

<b>dot1x auth-mode</b>	802.1x
<b>dot1x max-req</b>	
<b>dot1x port-control auto</b>	
<b>dot1x reauth-max</b>	
<b>dot1x re-authentication</b>	
<b>dot1x timeout quiet-period</b>	
<b>dot1x timeout re-authperiod</b>	
<b>dot1x timeout server-timeout</b>	
<b>dot1x timeout supp-timeout</b>	
<b>dot1x timeout tx-period</b>	

└───

-	-

### 30.6.6 show dot1x port-control

**show dot1x port-control [interface *interface*]**

<i>interface</i>	

└──

└──

└──

```
Ruijie# show dot1x port-control
interface dyn-user static-user max-user qos
ctrl-mode status
-----
Gi0/1      0          1          6000      dscp: 0 mac-base Authed
Ruijie#
```

<b>dot1x auth-mode</b>	802.1x
<b>dot1x max-req</b>	
<b>dot1x port-control auto</b>	
<b>dot1x reauth-max</b>	
<b>dot1x re-authentication</b>	
<b>dot1x timeout quiet-period</b>	
<b>dot1x timeout re-authperiod</b>	

	<b>dot1x timeout server-timeout</b>	
	<b>dot1x timeout supp-timeout</b>	
	<b>dot1x timeout tx-period</b>	

---



<b>dot1x auth-mode</b>	802.1x
<b>dot1x max-req</b>	
<b>dot1x port-control auto</b>	
<b>dot1x reauth-max</b>	
<b>dot1x re-authentication</b>	
<b>dot1x timeout quiet-period</b>	
<b>dot1x timeout re-authperiod</b>	
<b>dot1x timeout server-timeout</b>	
<b>dot1x timeout supp-timeout</b>	
<b>dot1x timeout tx-period</b>	

└───

-	-

### 30.6.9 show dot1x reauth-max

**show dot1x reauth-max**

-	-

└───

└───

└───

```
Ruijie# show dot1x reauth-max
reauth-max: 2 times
Ruijie#
```

<b>dot1x auth-mode</b>	802.1x
<b>dot1x max-req</b>	
<b>dot1x port-control auto</b>	
<b>dot1x reauth-max</b>	
<b>dot1x re-authentication</b>	
<b>dot1x timeout quiet-period</b>	
<b>dot1x timeout re-authperiod</b>	
<b>dot1x timeout server-timeout</b>	
<b>dot1x timeout supp-timeout</b>	
<b>dot1x timeout tx-period</b>	

-	-

### 30.6.10 show dot1x summary

802.1X

**show dot1x summary**

-	-

```

Ruijie# show dot1x summary
ID      MAC          Interface VLAN Auth-State
Backend-State Port-Status Type
-----
1 00d0f8000000 Gi0/1      1 Authenticated Idle
Authed   Static
Ruijie#
    
```

<b>dot1x auth-mode</b>	802.1x
<b>dot1x max-req</b>	
<b>dot1x port-control auto</b>	
<b>dot1x reauth-max</b>	
<b>dot1x re-authentication</b>	
<b>dot1x timeout quiet-period</b>	
<b>dot1x timeout re-authperiod</b>	
<b>dot1x timeout server-timeout</b>	
<b>dot1x timeout supp-timeout</b>	
<b>dot1x timeout tx-period</b>	

-	-
---	---

## 30.6.11 show dot1x user id

802.1X

**show dot1x user id <id>**

<i>id</i>	show summary	<i>id</i>
-----------	--------------	-----------

```
Ruijie# show dot1x user id 1
```

```
User name: caikov
```

```
id: 1
```

```
Type: static
```

```
Mac address is 0013.2049.8272
```

```
Vlan id is 217
```

```
Access from port Gi0/13
```

```
User ip address is 192.168.217.64
```

```
Max user number on this port is 6000
```

```
COS on this port is 5
```

```
Up-bandwidth is 1024 kbps
```

```
Down-bandwidth is 1024 kbps
```

```
Authorization vlan is dep7
```

```
Authorization session time is 1000000 seconds
```

```
Authorization ip address is 192.168.217.64
```

```
Start accounting
```

```
Permit proxy user
```

```
Permit dial user
```

```
IP privilege is 2
```

<b>dot1x auth-mode</b>	802.1x
------------------------	--------

<b>dot1x max-req</b>	
<b>dot1x port-control auto</b>	

```
Ruijie# show dot1x timeout quiet-period
quiet-period: 60 sec
Ruijie#
```

<b>dot1x auth-mode</b>	802.1x
<b>dot1x max-req</b>	
<b>dot1x port-control auto</b>	
<b>dot1x reauth-max</b>	
<b>dot1x re-authentication</b>	

```
dot1x timeo/Tpf-0.0024 Tw 1.198 <4-0.0024 Tw 1.] 0.47A48 20.1 33.36 394.9840.1 F909E20804
```

# 31 AAA

## 31.1

### 31.1.1 aaa authentication dot1x

AAA



AAA Enable

RADIUS

RADIUS

```
Ruijie(config)# aaa authentication enable default group radius local
```

<b>aaa new-model</b>	AAA
<b>enable</b>	
<b>username</b>	

-	-

### 31.1.3 aaa authentication login

AAA

Login

**aaa authentication login**

```
Login no
```

```
aaa authentication login {default | list-name} method1 [method2...]
```

```
no aaa authentication login {default | list-name}
```

<b>default</b>	Login
<i>list-name</i>	Login
<i>method</i>	local none group 4
<b>local</b>	
<b>none</b>	
<b>group</b>	TACACS+ RADIUS

┌

├

```

AAA
aaa authentication login
Login
AAA Login
Login

```

├

```

list-1 AAA Login
RADIUS RADIUS
Ruijie(config)# aaa authentication login list-1 group radius local

```

├

<b>aaa new-model</b>	AAA
<b>username</b>	
<b>login authentication</b>	Login

├

├

-	-

### 31.1.4 aaa authentication ppp

```

AAA PPP
aaa authentication ppp PPP

```

<b>local</b>	
<b>none</b>	
<b>group</b>	TACACS+ RADIUS

┌  
└

```

AAA PPP
aaa authentication ppp AAA PPP PPP
    
```

```

rds_ppp AAA PPP
RADIUS RADIUS
Ruijie(config)# aaa authentication ppp rds_ppp group radius local
    
```

<b>aaa new-model</b>	AAA
<b>ppp authentication</b>	PPP
<b>username</b>	

┌  
└

-	-
---	---

### 31.1.5 login authentication

```

authentication Login no login
    
```

**login authentication {default | list-name}**

**no login authentication**

--	--

---

<b>default</b>	Login
<i>list-name</i>	Login

---

Login  
Login  
Login

```
list-1 AAA Login
VTY 0 - 4
Ruijie(config)# aaa authentication login list-1 local
Ruijie(config)# line vty 0 4
Ruijie(config-line)# login authentication list-1
```

**no aaa authorization commands** *level* {**default** | *list-name*}

<i>level</i>	0~15
<b>default</b>	Q



-	-

└──

└──

└── RGOS

└── Ruijie(config)# **aaa authorization console**

<b>aaa new-model</b>	AAA
<b>aaa authorization commands</b>	AAA
<b>authorization commands</b>	

└──

-	-

### 31.2.4 aaa authorization exec

AAA          NAS    CLI                    Exec  
**aaa authorization exec**          no          AAA Exec

**aaa authorization exec** {default | *list-name*} *method1* [*method2...*]

**no aaa authorization exec** {default | *list-name*}

<b>default</b>	Exec
<i>list-name</i>	Exec

AAA

<b>default</b>	Network
<i>method</i>	

**authorization****commands** no**authorization commands** *level* {**default** | *list-name*}**no authorization commands** *level*

<i>level</i>	0~15
<b>default</b>	
<i>list-name</i>	

AAA

cmd

15

TACACS+

none

VTY 0-4

Ruijie(config)# **aaa authorization commands 15 cmd group tacacs+ none**Ruijie(config)# **line vty 0 4**Ruijie(config-line)# **authorization commands 15 cmd**

<b>aaa new-model</b>	AAA
<b>aaa authorization commands</b>	AAA

Exec

**authorization exec**

no

Exec

**authorization exec {default | list-name}****no authorization exec**

<b>default</b>	Exec
<i>list-name</i>	Exec

AAA Exec

Exec

Exec

Exec

Exec

exec-1 Exec

RADIUS

none

VTY 0 – 4

Ruijie(config)# **aaa authorization exec exec-1 group radius none**Ruijie(config)# **line vty 0 4**Ruijie(config-line)# **authorization exec exec-1**

<b>aaa new-model</b>	AAA
<b>aaa authorization commands</b>	AAA Exec

-	-

## 31.3

## NAS

**aaa accounting commands** no

**aaa accounting commands** *level* {**default** | *list-name*} **start-stop** *method1* [*method2...*]

**no aaa accounting commands** *level* {**default** | *list-name*}

<i>level</i>	0~15
<b>default</b>	
<i>list-name</i>	
<i>method</i>	<b>none group</b> 4 "

-	-

### 31.3.2 aaa accounting exec

**accounting exec**                      no                      NAS                      Exec                      **aaa**

**aaa accounting exec** {**default** | *list-name*} **start-stop** *method1* [*method2...*]

**no aaa accounting exec** {**default** | *list-name*}

<b>default</b>	Exec
<i>list-name</i>	Exec
<i>method</i>	<b>none group</b> 4
<b>none</b>	



```
Ruijie(config)# aaa accounting network default start-stop group radius
```

aaa new-model	AAA
aaa authorization network	AAA
aaa authentication	AAA
username	

-	-
---	---

### 31.3.4 aaa accounting update

aaa accounting update

no

aaa accounting update

no aaa accounting update

-	-
---	---

AAA

AAA

```
Ruijie(config)# aaa new-model
```

```
Ruijie(config)#
```

--	--

	<b>aaa new-model</b>	AAA
	<b>aaa accounting network</b>	



---

	-	-

### 31.3.6 accounting commands

#### accounting commands

no

**accounting commands** *level* {**default** | *list-name*}

**no accounting commands** *level*

<i>level</i>	0~15
<b>default</b>	

-	-

### 31.3.7 accounting exec

Exec

no

Exec

**accounting exec****accounting exec** {default | *list-name*}**no accounting exec**

<b>default</b>	Exec
<i>list-name</i>	Exec

┌

└

┌

└

┌

└

Exec

Exec

Exec

Exec

┌

└

exec-1 Exec

none

RADIUS

VTY 0 – 4

```
Ruijie(config)# aaa accounting exec exec-1 group radius none
```

```
Ruijie(config)# line vty 0 4
```

```
Ruijie(config-line)# accounting exec exec-1
```

<b>aaa new-model</b>	AAA
<b>aaa accounting commands</b>	AAA Exec

┌

└

┌

└

--	--

	-	-
--	---	---

## 31.4 AAA

### 31.4.1 aaa domain

no

**aaa domain** {**default** | *domain-name*}

**no aaa domain** {**default** | *domain-name*}

	<b>default</b>	
	<i>domain-name</i>	

┌

┌

┌

AAA            default  
                  *domain-name*

32

┌

```
Ruijie(config)# aaa domain ruijie.com
Ruijie(config-aaa-domain)#
```

	<b>aaa new-model</b>	AAA
	<b>aaa domain enable</b>	AAA
	<b>show aaa domain</b>	

┌

┌

--	--	--

### 31.4.2 aaa domain enable

AAA  
 AAA no

**aaa domain enable**

**no aaa domain enable**

-	-

┌  
└

AAA

┌  
└

AAA

┌  
└

AAA  
 Ruijie(config)# **aaa domain enable**

┌  
└

<b>aaa new-model</b>	AAA
<b>show aaa domain</b>	

┌  
└

┌  
└

-	-

### 31.4.3 access-limit



default

Network

Network

Ruijie(config)# **aaa domain ruijie.com**

Ruijie(config-aaa-domain)# **accounting network default**

<b>aaa new-model</b>	AAA
<b>aaa domain enable</b>	AAA
<b>show aaa domain</b>	

-	-

### 31.4.5 authentication dot1x

IEEE802.1x

no

**authentication dot1x {default | list-name}**

**no authentication dot1x**

<b>default</b>	
<i>list-name</i>	

default

```
IEEE802.1x
```

```
IEEE802.1x
```

```
Ruijie(config)# aaa domain ruijie.com
```

```
Ruijie(config-aaa-domain)# authentication dot1x default
```

<b>aaa new-model</b>	AAA
<b>aaa domain enable</b>	AAA
<b>show aaa domain</b>	

-	-

### 31.4.6 authorization network

```
Network no
```

```
authorization network {default | list-name}
```

```
no authorization network
```

<b>default</b>	
<i>list-name</i>	

```
default
```

```
Ruijie(config)# aaa domain ruijie.com
```

```
Ruijie(config-aaa-domain)# authorization network default
```

<b>aaa new-model</b>	AAA
<b>aaa domain enable</b>	AAA
<b>show aaa domain</b>	

-	-

### 31.4.7 state

no

**state {block | active}**

**no state**

<b>block</b>	
<b>active</b>	

```
Ruijie(config)# aaa domain ruijie.com
```

```
Ruijie(config-aaa-domain)# state block
```

--	--

<b>aaa new-model</b>	AAA
<b>aaa domain enable</b>	AAA
<b>show aaa domain</b>	

AAA

---

**aaa new-model**

AAA

-	-

## 31.5 AAA

### 31.5.1 aaa group server

AAA no

**aaa group server {radius | tacacs+} name**

**no aaa group server {radius | tacacs+} name**

<i>name</i>	tacacs+	RADIUS	radius TACACS+

AAA RADIUS TACACS+

```
Ruijie(config)# aaa group server radius ss
```

```
Ruijie(config-gs-radius)# end
```

```
Ruijie# show aaa group
```

```
Group Name: ss
```

```
Group Type: radius
```

```
Referred: 1
```

```
Server List:
```

<b>show aaa group</b>	aaa

	-	-

### 31.5.2 ip vrf forwarding

AAA vrf no

**ip vrf forwarding** *vrf\_name*

**no ip vrf forwarding**

	<i>vrf_name</i>	vrf

└──

└──

└──

vrf

```
Ruijie(config)# aaa group server radius ss
Ruijie(config-gs-radius)# server 192.168.4.12
Ruijie(config-gs-radius)# server 192.168.4.13
Ruijie(config-gs-radius)# ip vrf forwarding vrf_name
Ruijie(config-gs-radius)# end
```

	<b>aaa group server</b>	aaa
	<b>show aaa group</b>	aaa

└──

AAA no

**server** *ip-addr* [**authen-port** *port1*] [**acct-port** *port2*]

**no server**

AAA

---

	-	-
--	---	---

### 31.5.4 show aaa group

AAA

**show aaa group**



### 31.6.1 aaa local authentication attempts

login

**aaa local authentication attempts** *max-attempts*

	<i>max-attempts</i>	1~2147483647

|

3

|

|

Login

D

|

| login

|

Ruijie# **configure terminal**  
 Ruijie(config)# **aaa local authentication lockout-time 5**

|

<b>Show running-config</b>	
<b>Show aaa lockout</b>	login

|

|

-	-

### 31.6.3 aaa new-model

RGOS AAA **aaa new-model** AAA  
 no AAA

**aaa new-model**

**no aaa new-model**

|

-	-

| AAA

|

|

AAA AAA **aaa new-model**  
 AAA AAA AAA

|

AAA  
 Ruijie(config)# **aaa new-model**

	<b>aaa authentication</b>	
	<b>aaa authorization</b>	
	<b>aaa accounting</b>	

└───┘

	-	-

### 31.6.4 clear aaa local user lockout

**clear aaa local user lockout {all | user-name <word>}**

	<word>	ID

└───┘

└───┘

### 31.6.5 debug aaa

AAA

no

debug aaa event

no debug aaa event

	-	-

┌

┌ EXEC

┌

┌

	-	-

┌

	-	-

### 31.6.6 show aaa method-list

AAA

show aaa method-list

	-	-

┌

~

```
AAA
```

```
AAA
```

```
Ruijie# show aaa method-list
Authentication method-list
aaa authentication login default group radius
aaa authentication ppp default group radius
aaa authentication dot1x default group radius
aaa authentication dot1x san-f local group angel group rain none
aaa authentication enable default group radius
Accounting method-list
aaa accounting network default start-stop group radius
Authorization method-list
aaa authorizing network default group radius
```

<b>aaa authentication</b>	
<b>aaa authorization</b>	
<b>aaa accounting</b>	

-	-

### 31.6.7 show aaa user lockout

```
show aaa user lockout {all | user-name <word>}
```

<word>	ID

|

|

Ruijie# **show aaa user lockout all**

|

<b>show running-config</b>	
<b>show aaa lockout</b>	login

|

|

-	-



### 32.1.2 radius attribute

**radius ttribute**{<id> | **down-rate-limit** | **dscp** | **mac-limit** | **up-rate-limit**} **vendor-type**  
<type>

**no radius attribute** {<id>|**down-rate-limit** | **dscp** | **mac-limit** | **up-rate-limit**} **vendor-type**

<i>id</i>	id <1-255>
<i>type</i>	type

id		type
1	max down-rate	1
2	qos	2
3	user ip	3
4	vlan id	4
5	version to client	5
6	net ip	6
7	user name	7
8	password	8
9	file-diractory	9
10	file-count	10
11	file-name-0	11
12	file-name-1	12
13	file-name-2	13
14	file-name-3	14
15	file-name-4	15
16	max up-rate	16
17	version to server	17
18	flux-max-high32	18
19	flux-max-low32	19
20	proxy-avoid	20
21	dailup-avoid	21
22	ip privilege	22

23	login privile	42
----	---------------	----





RADIUS

---

**radius-server key**

RADIUS

**radius-server retransmit**

RADIUS

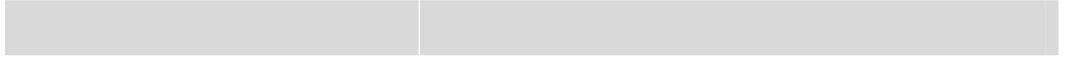

RADIUS

**radius-server timeout no**

**radius-server timeout *seconds***

**no radius-server timeout**

<i>seconds</i>		1-1000

5

10  
Ruijie(config)# **radius-server timeout 10**

<b>radius-server host</b>		RADIUS
<b>radius-server retransmit</b>		RADIUS
<b>radius-server key</b>		RADIUS

-		-

### 32.1.8 radius set qos cos

radius qos cos

**radius set qos cos**

**no radius set qos cos**

-		-

└── qos      dscp

└──

qos



RADIUS

**show radius parameter**

-	-

|

|

|

radius

|

```
Ruijie# show radius parameter  
Server Timeout: 5 Seconds  
Server Deadtime: 5 Minutes  
Server Retries: 3  
Server Key: *****
```

|

<b>radius-server host</b>	RADIUS
<b>radius-server retransmit</b>	RADIUS
<b>radius-server key</b>	RADIUS
<b>radius-server timeout</b>	RADIUS

|

|

-	-

┌

┌

┌

radius

┌

```
Ruijie# show radius server
server ip : 192.168.4.12
acct port: 23
authen port: 77
server state: ready
server ip : 192.168.4.13
acct port: 45
authen port: 74
server state: ready
```

<b>radius-server host</b>	RADIUS
<b>radius-server retransmit</b>	RADIUS
<b>radius-server key</b>	RADIUS
<b>radius-server timeout</b>	RADIUS

┌

┌

-	-

### 32.2.4 show radius vendor-specific

RADIUS

**show radius vendor-specific**

┌

-	-

┌

|  
|  
|

|  
|  
|

radius

```
Ruijie# show radius vendor-specific
id  vendor-specific      type-value
-----
1   max down-rate       76
2   qos                  77
3   user ip              3
4   vlan id              4
5   version to client    5
6   net ip               6
7   user name            7
8   password             8
```

RADIUS

---

L

L

-	-

# 33 TACACS+

## 33.1 TACACS+

### 33.1.1 aaa group server tacacs+

TACACS+

TACACS+

```
aaa group server tacacs+ group-name
```

```
no aaa group server tacacs+ group-name
```

	<i>group-name</i>	TACACS+

```
TACACS+
```

```
TACACS+
```

```

tac1 TACACS+ 1.1.1.1
TACACS+
Ruijie(config)# aaa group server tacacs+ tac1
Ruijie(config-gs-tacacs)# server 1.1.1.1

```

<b>server</b>	TACACS+	server
<b>ip vrf forwarding</b>	TACACS+	VRF

-		-

### 33.1.2 ip tacacs source-interface

TACACS+

**ip tacacs source-interface** *interface*

**no ip tacacs source-interface**



<i>vrf-name</i>	vrf
-----------------	-----

┌

TACACS+

TACACS+ vrf

```

TACACS+ VRF vpn1
Ruijie(config)# aaa group server tacacs+ tac1
Ruijie(config-gs-radius)# server 1.1.1.1
Ruijie(config-gs-radius)# ip vrf forwarding vpn1
    
```

<b>aaa group server tacacs+</b>	TACACS+
<b>server</b>	TACACS+ server

┌

--	--

```
TACACS+
host
```

**aaa group server tacacs+**

```
TACACS+
tacacs-server
```

```
TACACS+
tac1 TACACS+ 1.1.1.1
```

```
TACACS+
Ruijie(config)# aaa group server tacacs+ tac1
Ruijie(config-gs-tacacs+)# server 1.1.1.1
```

|

|

TACACS+    AAA    TACACS+  
**tacacs-server**    TACACS+

|

TACACS+  
Ruijie(config)# **tacacs-server host** 192.168.12.1  
Ruijie(config)# **tacacs-server host** 2001::1

|

<b>aaa authentication</b>	AAA
<b>tacacs-server key</b>	TACACS+
<b>tacacs-server timeout</b>	TACACS+

|

|

\_\_\_\_\_

```

key                               host      key

```

```

TACACS+
Ruijie(config)#tacacs-server key aaa

```

<b>tacacs-server host</b>	TACACS+
<b>tacacs-server timeout</b>	TACACS+

-	-

### 33.1.7 tacacs-server timeout

TACACS+

**tacacs-server timeout** *seconds*

**no tacacs-server timeout**

--	--

*seconds*

<b>tacacs-server host</b>	TACACS+
<b>tacacs-server key</b>	TACACS+

	-	

## 33.2 TACACS+

### 33.2.1 debug tacacs+

TACACS+                      no                      TACACS+

**debug tacacs+**

**no debug tacacs+**

--	--

### 33.2.2 show tacacs

TACACS+

**show tacacs**

	-	-

|

|

|

TACACS+

```
Ruijie# show tacacs
Tacacs+ Server : 172.19.192.80/49
Socket Opens: 0
Socket Closes: 0
Total Packets Sent: 0
Total Packets Recv: 0
Reference Count: 0
```

|

<b>tacacs-server host</b>	TACACS+

|

|

-	-

## 34 SSH

### 34.1 SSH

#### 34.1.1 crypto key generate

**crypto key generate {rsa | dsa}**

<b>rsa</b>	RSA
<b>dsa</b>	DSA

SSH Server

SSH Server

SSH

**enable service ssh-server**

SSH Server

SSH 1

RSA

SSH

2 RSA DSA

RSA

SSH1

SSH2

DSA

SSH2

**no crypto key generate**



**crypto key zeroize**

Ruijie# **configure terminal**

Ruijie(config)# **crypto key generate rsa**

<b>show ip ssh</b>	SSH Server
<b>crypto key zeroize {rsa   dsa}</b>	DSA RSA SSH Server

RGOS10.1

	-	-
--	---	---

### 34.1.2 crypto key zeroize

SSH

**crypto key zeroize {rsa / dsa}**

<b>rsa</b>		RSA
<b>dsa</b>		DSA

--

--

	SSH Server	SSH Server	DISABLE
		<b>no enable service ssh-server</b>	

```
Ruijie# configure terminal
Ruijie(config)# crypto key zeroize rsa
```

<b>show ip ssh</b>		SSH Server
<b>crypto key generate {rsa dsa}</b>		DSA RSA

RGOS10.1

-		-

### 34.1.3 ip ssh authentication-retries

SSH Server

no

**ip ssh authentication-retries** *retry times*

**no ip ssh authentication-retries**

<i>retry times</i>	

3 no ip ssh

**authentication-retries**

SSH Server SSH Server

**show ip ssh** SSH Server

2

Ruijie# **configure terminal**

Ruijie(config)# **ip ssh ssh authentication-retries 2**

<b>show ip ssh</b>	SSH Server

RGOS10.1

-	-

### 34.1.4 ip ssh time-out

SSH Server no

**ip ssh time-out** *time*

**no ip ssh time-out**

<i>time</i>	

120s no ip ssh time-out



SSH Server  
120s

2

Ruijie# **configure terminal**

Ruijie(config)# **ip ssh version 2**

**show ip ssh**

SSH Server

RGOS10.1

	Clear line vty <i>line_number</i>	VTY
	RGOS10.1	
	-	-

### 34.2.2 show crypto key mypubkey

SSH Server

**show crypto key mypubkey {rsa/dsa}**

	<b>rsa</b>	RSA
	<b>dsa</b>	DSA

SSH Server

Ruijie# **show crypto key mypubkey rsa**

	<b>crypto key generate {rsa   dsa}</b>	DSA RSA
	RGOS10.1	
	-	-

### 34.2.3 show ip ssh

SSH Server

**show ip ssh**

	-	-

└───┘

└───┘

SSH Server	SSH Server
SSH	
SSH	

Ruijie# **show ip ssh**

<b>ip ssh version {1   2}</b>	SSH Server
<b>ip ssh time-out time</b>	SSH Server
<b>ip ssh authentication-retries retry times</b>	SSH Server

RGOS10.1

-	-

**34.2.4 show ssh**

SSH

**show ssh**

-	-

└───┘

|

|

SSH

VTY

SSH

|

Ruijie# **show ssh**

|

-	-

|

RGOS10.1

|

--	--

## 35 CPU

### 35.1

#### 35.1.1 `cpu-protect type packet-type pps pps_value`

CPU

```
cpu-protect type { arp | bpdu | dhcp | ipv6mc | igmp | rip | ospf | vrrp | pim | ttl1 |  
unknown-ipmc | dvmrp | ... } pps pps_value
```

CPU

CPU

```

S9610 CPU
Ruijie# show cpu-protect mboard
type      Pps      Total    Drop
-----
arp       500      19       0
bpdu     200      24       0
dhcp      0        0        0
gvrp      0        0        0
ipv6-mc   0        0        0
dvmrp     0        0        0
igmp      0        0        0
ospf      0        0        0
pim       0        0        0
rip       0        0        0
vrrp      0        0        0
unknow-ipmc 0        0        0
ttl1     0        0        0
...

```

<b>show cpu-protect slot <i>slot-num</i></b>	CPU

-	-

### 35.2.2 show cpu-protect slot

CPP

**show cpu-protect slot *slot\_num***

--	--

<i>slot_num</i>	1-16
-----------------	------

CPP

2 CPU

Ruijie(config)# **show cpu-protect slot 2**

Type	Pps	Total	Drop
arp	200	200	15
bpdu	200	8	0
dhcp	200	0	0
gvrp	200	0	0
ipv6-mc	200	0	0
dvmrp	200	0	0
igmp	200	0	0
ospf	200	0	0
pim	200	0	0
rip	200	0	0
vrrp	200	0	0
unknow-ipmc	200	0	0
ttl1	20	3	0

<b>show cpu-protect mboard</b>	CPU
--------------------------------	-----

-	-
---	---

### 35.2.3 show cpu-protect type

**show cpu-protect type** { arp | bpdu | dhcp | ipv6mc | igmp | rip | ospf | vrrp | pim | ttl1 | unknown-ipmc | dvmrp | ...} *dvmrp*

<i>slot_num</i>	1-16

|

|

|

```

show cpu-protect type bpdu          BPDU
Ruijie(config)# show cpu-protect type arp
Slot      Type      Pps      Total    Drop
-----
MainBoard bpdu      100      30      0
Slot-2    bpdu      100      30      0

```

<b>show cpu-protect type</b> <i>packet-type</i>	CPU

-

-	-

 CPP      "..."      CPP

# 36 DoS

## 36.1

### 36.1.1 ip deny invalid-l4port

no

ip deny invalid-l4port

no ip deny invalid-l4port

	-	-

┌

┌

┌

1  
Ruijie(config)# ip deny invalid-l4port

2  
Ruijie(config)# no ip deny invalid-l4port

	show ip deny invalid-l4port	

┌

	-	-

### 36.1.2 ip deny invalid-tcp

	TCP	no	TCP
<b>ip deny invalid-tcp</b>			
<b>no ip deny invalid-tcp</b>			
	-		-

```
┌ TCP
```

```
┌
```

```
┌
```

```
1 TCP
Ruijie(config)# ip deny invalid-tcp
2 TCP
Ruijie(config)# no ip deny invalid-tcp
```

<b>show ip deny invalid-tcp</b>	TCP	P532A>6<0B9TJ
---------------------------------	-----	---------------

|

|

|

```
1 Land
Ruijie(config)# ip deny land
2 Land
Ruijie(config)# no ip deny land
```

|

show ip deny land	Land

|

-

|

-	-

## 36.2

### 36.2.1 show ip deny invalid-l4port

#### show ip deny invalid-l4port

|

-	-

|

|

|

|

```
Ruijie# show ip deny invalid-l4port
DoS Protection Mode          State
-----
```

```
protect against invalid l4port attack Off
```

-	-

-	-

### 36.2.2 show ip deny invalid-tcp

TCP

**show ip deny invalid-tcp**

-	-

```
Ruijie# show ip deny invalid-tcp
```

```
DoS Protection Mode                State
-----
```

protect against invalid tcp attack On

<b>(no) ip deny invalid-tcp</b>	TCP

-	-

### **36.2.3 show ip deny land**

Land

**show ip deny land**

# 37 GSN

## 37.1

### 37.1.1 security address-bind enable

security address-bind enable

no security address-bind enable

	-	-

┌

┌

AP AP

┌

GSN

┌

Ruijie(config-if)# security address-bind enable

┌

	<b>security gsn enable</b>	GSN

┌

RGOS10.1

┌

	-	-

### 37.1.2 security community

smp

**security** { [ v1 | v2 ] **community** *community* | v3 **user** *username* }

**no security** { [ v1 | v2 ] **community** *community* | v3 **user** *username* }

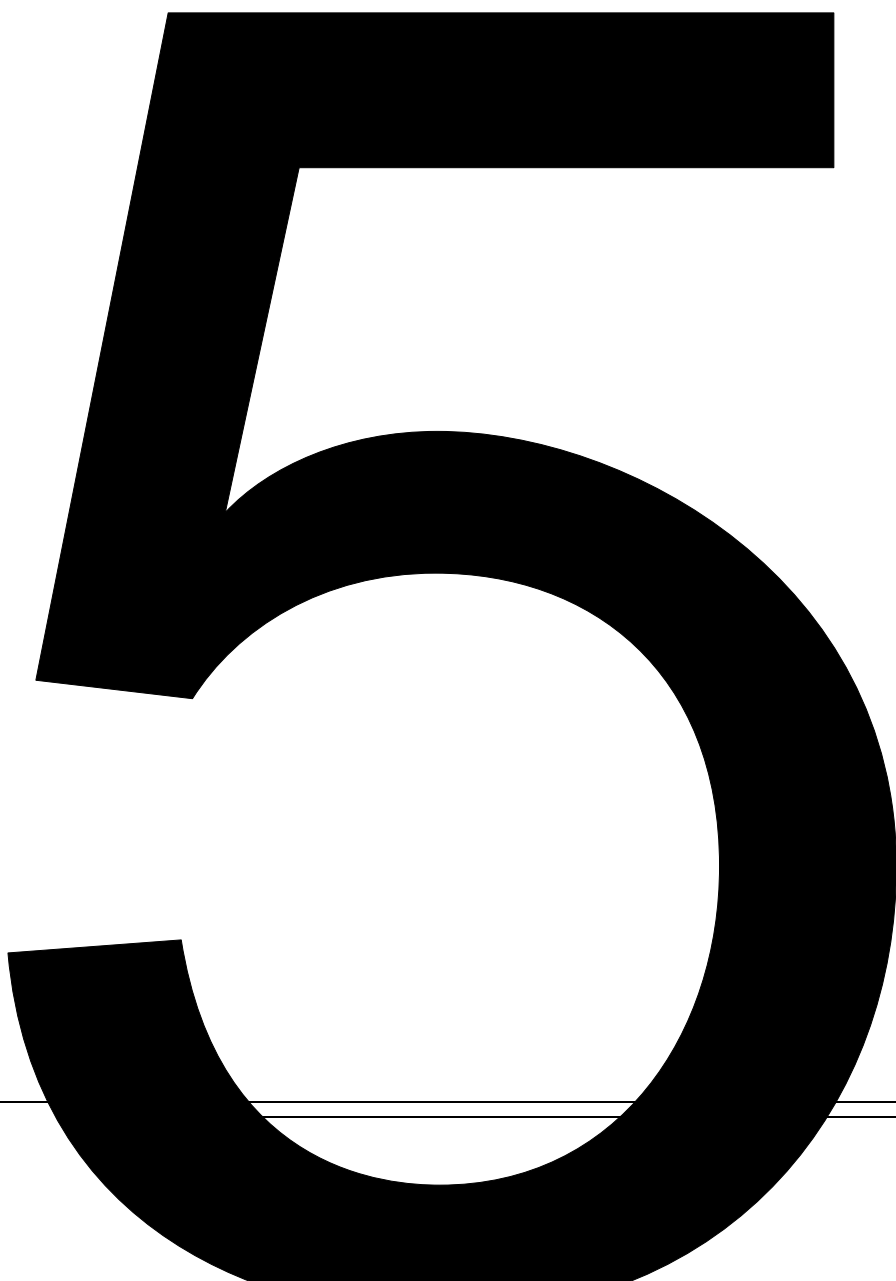
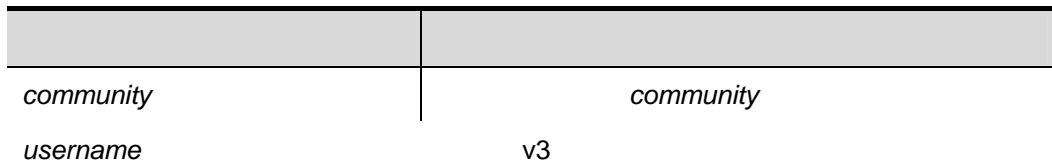



	-	-
	RGOS10.1	
	-	-

### 37.1.5 smp-server host

smp-server ip

**smp-server host** *ip-address*

**no smp-server host**

	<i>ip-address</i>	smp server ip

smp server

**show smp-server**

Ruijie(config)#**smp-server host** 192.168.4.243

	<b>show smp-server</b>	smp server

RGOS10.1

	-	-

## 37.2

### 37.2.1 show security evnet interval

	-	-

┌

┌

┌

┌  
Ruijie# **show security event interval**  
Event sending interval(Seconds):5

	<b>security event interval</b>	<i>interval</i>

┌  
RGOS10.1

	-	-

### 37.2.2 show smp-server

smp server IP

	-	-

┌

┌

┌  
smp server IP

┌  
Ruijie# **show smp-server**

SMP-Server IP 192.168.20.30

<b>smp-server host</b>	smp server ip

RGOS10.1

-	-

# 38 DAI

## 38.1 VLAN DAI

### 38.1.1 ip arp inspection vlan

*vlan-id* VLAN DAI *vlan-id* no VLAN  
DAI

**ip arp inspection vlan** *vlan-id*

**no ip arp inspection vlan** [*vlan-id*]



## 38.2

### 38.2.1 ip arp inspection trust

ip arp inspection trust                      no

ip arp inspection trust

no ip arp inspection trust

-	-

┌

┌

ARP	DAI
NFPP(	) NFPP
/ DAI	show ip arp inspection interface

┌  
Ruijie(config)# interface gigabitEthernet 0/19  
Ruijie(config-if)# ip arp inspection trust

show ip arp inspection interface	DAI

┌

-	-

## 38.3 DHCP Snooping



**39**

**arp**

arp

**show anti-arp-spoofing**

|

|

|

```
Ruijie#show anti-arp-spoofing
      port      ip
      -----  -
      Fa0/1     192.168.1.1
```

<b>anti-arp-spoofing ip</b>	arp

|

-	-

# 40 IP Source Guard

## 40.1 IP Source Guard

### 40.1.1 ip source binding

IP no

[no] ip source binding *mac-address* **vlan** *vlan-id* *ip-address* **interface** *interface-id*

<i>mac-address</i>	MAC
<i>vlan-id</i>	vlan id
<i>ip-address</i>	IP
<i>interface-id</i>	

|

|

|

IP Source Guard

DHCP

|

```

1
Ruijie# configure terminal
Ruijie(config)# ip source binding 0000.0000.0001 vlan 1 1.1.1.1
interface FastEthernet 0/1
Ruijie(config)# end
Ruijie# show ip source binding
MacAddress      IpAddress  Lease(sec)  Type   VLAN  Interface
-----
0000.0000.0001 1.1.1.1   infinite   static  1    FastEthernet 0/1
Total number of bindings: 1
    
```

--	--

	<b>show ip source binding</b>	IP
	-	-

## 40.2 IP Source Guard

### 40.2.1 ip verify source

```

IP Source Guard      no
[no] ip verify source [port-security]

```

	<b>port-security</b>	IP Source Guard      IP+MAC

```

IP Source Guard      IP
IP+MAC
IP Source Guard      DHCP Snooping      Trust
DHCP Snooping      IP Source Guard      IP Source Guard

```

```

1      IP Source Guard
Ruijie# configure terminal
Ruijie(config)# interface fastEthernet 0/1
Ruijie(config-if)# ip verify source
Ruijie(config-if)# end

```

-	-

## 40.3 IP Source Guard

### 40.3.1 show ip source binding

IP

**show ip source binding** [*ip-address*] [*mac-address*] [**dhcp-snooping**] [**static**] [*vlan vlan-id*] [**interface** *interface-id*]

<i>ip-address</i>	ip
<i>mac-address</i>	mac
dhcp-snooping	
static	
<i>vlan-id</i>	vlan
<i>interface-id</i>	

└───┘

└───┘

└───┘

└───┘

```
Ruijie# show ip source binding static
MacAddress   IpAddress  Lease(sec)  Type   VLAN  Interface
-----
0000.0000.0001 1.0.0.1   infinite   static    1   FastEthernet 0/1
Total number of bindings: 1
```



|

---

|

---

-	-

└──

└──

-	-



**cpu-protect sub-interface {manage|protocol|route} percent percent\_vaule**

<i>percent_vaule</i>	1	100

(Manage)	30
(Route)	25
(Protocol)	45

┌

┌

Ruijie(config)# **cpu-protect sub-interface manage percent 60**

<b>cpu-protect sub-interface { manage   protocol / route } pps</b>	

┌

**e2 0 .62TF[ 368.18 -144.24 -19.62/15203 Tm03 Tm03 Tf0 Tf0.006 Tc 2 Tr 10.02 0 0 3 Tm( )TF[ 3681**

## 41.3 ARP

### 41.3.1 arp-guard attack-threshold

**arp-guard attack-threshold** {per-src-ip | per-src-mac | per-port} pps

	<b>per-src-ip</b>	IP
	<b>per-src-mac</b>	MAC
	<b>per-port</b>	
	<i>pps</i>	[1,9999]

```

IP          MAC          8
200

```

```

NFPP

```

```

Ruijie(config)#

```

### 41.3.2 arp-guard enable

ARP

**arp-guard enable**

-	-

ARP

NFPP

```
Ruijie(config)# nfpp
Ruijie(config-nfpp)# arp-guard enable
```

<b>nfpp arp-guard enable</b>	ARP
<b>show nfpp arp-guard summary</b>	

-	-

### 41.3.3 arp-guard isolate-period

**arp-guard isolate-period** {seconds | permanent} , Q A

NFPP

```
Ruijie(config)# nfpp
Ruijie(config-nfpp)# arp-guard isolate-period 180
```

<b>nfpp arp-guard isolate-period</b>	
<b>show nfpp arp-guard summary</b>	

-	-

### 41.3.4 arp-guard monitor-period

**arp-guard monitor-period** *seconds*

<i>seconds</i>	[180, 86400]

600

NFPP

```
> 0
0
>
```

```
Ruijie(config)# nfpp
```

```
Ruijie(config-nfpp)# arp-guard monitor-period 180
```

**show nfpp arp-guard summary**

	-	-

### 41.3.7 arp-guard scan-threshold

#### arp-guard scan-threshold *pkt-cnt*

	<i>pkt-cnt</i>	[1,9999]

	15	10
--	----	----

NFPP

10	15	ARP	MAC	IP
	MAC	IP	IP	

```
Ruijie(config)# nfpp
Ruijie(config-nfpp)# arp-guard scan-threshold 20
```

```
nfpp arp-guard scan-threshold
show nfpp arp-guard summary
```

**clear nfpp arp-guard hosts [vlan vid] [interface interface-id] [ip-address | mac-address]**

<i>vid</i>	
<i>interface-id</i>	
<i>ip-address</i>	IP
<i>mac-address</i>	MAC

└───┘

└───┘

└───┘

└───┘

VLAN 1      g 0/1  
 Ruijie# **clear nfpp arp-guard hosts vlan 1 interface g0/1**

<b>arp-guard attack-threshold</b>	
<b>nfpp arp-guard policy</b>	
<b>show nfpp arp-guard hosts</b>	

└───┘

-	-

**41.3.9 clear nfpp arp-guard scan**

ARP

**clear nfpp arp-guard scan**

-	-

└───┘

|

|

|

Ruijie# **clear nfpp arp-guard scan**

|

<b>arp-guard scan-threshold</b>	
<b>nfpp arp-guard scan-threshold</b>	
<b>show nfpp arp-guard scan</b>	ARP

|

|

-	-

### 41.3.10 nfpp arp-guard enable

ARP

**nfpp arp-guard enable**

|

-	-

|

ARP

|

|

ARP

ARP

|

Ruijie(config)# **interface G0/1**  
 Ruijie(config-if)# **nfpp arp-guard enable**

|

<b>arp-guard enable</b>	ARP
<b>show nfpp arp-guard summary</b>	

```

└───┘

```

10.4	

### 41.3.11 nfpp arp-guard isolate-period

**nfpp arp-guard isolate-period** {*seconds* | **permanent**}

<i>seconds</i>	0 [30, 86400]
<b>permanent</b>	0

```

└───┘

```

```

└───┘

```

```

└───┘

```

```

Ruijie(config)# interface G 0/1
Ruijie(config-if)# nfpp arp-guard isolate-period 180

```

**nfpp arp-guard policy {per-src-ip | per-src-mac | per-port} rate-limit-pps  
attack-threshold-pps**

<b>per-src-ip</b>	IP
<b>per-src-mac</b>	MAC
<b>per-port</b>	
<i>rate-limit-pps</i>	1 9999
<i>attack-threshold-pps</i>	1 9999

```
Ruijie(config)# interface G 0/1
Ruijie(config-if)# nfpp arp-guard policy per-src-ip 2 10
Ruijie(config-if)# nfpp arp-guard policy per-src-mac 3 10
Ruijie(config-if)# nfpp arp-guard policy per-port 50 100
```

<b>arp-guard attack-threshold</b>	
<b>arp-guard rate-limit</b>	
<b>show nfpp arp-guard summary</b>	
<b>show nfpp arp-guard hosts</b>	
<b>clear nfpp arp-guard hosts</b>	

10.4	
------	--

### 41.3.13 nfpp arp-guard scan-threshold

**nfpp arp-guard scan-threshold *pkt-cnt***

<i>pkt-cnt</i>	[1,9999]

	ARP	ARP
--	-----	-----

┌

┌

```
Ruijie(config)# interface G 0/1
Ruijie(config-if)# nfpp arp-guard scan-threshold 20
```

<b>arp-guard scan-threshold</b>	
<b>show nfpp arp-guard summary</b>	
<b>show nfpp arp-guard scan</b>	ARP
<b>clear nfpp arp-guard scan</b>	ARP

┌

10.4	

## 41.4 DHCP

### 41.4.1 dhcp-guard attack-threshold

**dhcp-guard attack-threshold { per-src-mac | per-port} *pps***

<b>per-src-mac</b>	MAC
<b>per-port</b>	

	<i>pps</i>	[1,9999]
--	------------	----------

	MAC	10	300
--	-----	----	-----

NFPP

```
Ruijie(config)# nfpp
Ruijie(config-nfpp)# dhcp-guard attack-threshold per-src-mac 15
Ruijie(config-nfpp)# dhcp-guard attack-threshold per-port 200
```

	<b>nfpp dhcp-guard policy</b>	
	<b>show nfpp dhcp-guard summary</b>	
	<b>show nfpp dhcp-guard hosts</b>	
	<b>clear nfpp dhcp-guard hosts</b>	

	-	-

### 41.4.2 dhcp-guard enable

DHCP

**dhcp-guard enable**

	-	-

DHCP

NFPP

```
Ruijie(config)# nfpp
Ruijie(config-nfpp)# dhcp-guard enable
```

<b>nfpp dhcp-guard enable</b>	DHCP
<b>show nfpp dhcp-guard summary</b>	

-	-

### 41.4.3 dhcp-guard isolate-period

**dhcp-guard isolate-period** {seconds | permanent}

<i>seconds</i>	0 [30, 86400]
<b>permanent</b>	0

0

NFPP

```
Ruijie(config)# nfpp
Ruijie(config-nfpp)# dhcp-guard isolate timeout 180
```

<b>nfpp dhcp-guard isolate-period</b>	

<b>show nfpp dhcp-guard summary</b>	
-	-

#### 41.4.4 dhcp-guard monitor-period

**dhcp-guard monitor- period seconds**

seconds	[180, 86400]

600

NFPP

> 0

0

>

```
Ruijie(config)# nfpp
Ruijie(config-nfpp)# dhcp-guard monitor-period 180
```

<b>show nfpp dhcp-guard summary</b>	
<b>show nfpp dhcp-guard hosts</b>	
<b>clear nfpp dhcp-guard hosts</b>	

--	--

NFPP

**dhcp-guard rate-limit { per-src-mac | per-port} pps**

<b>per-src-mac</b>	MAC
<b>per-port</b>	
<i>pps</i>	[1,9999]

MAC	5	150
-----	---	-----

NFPP

```
Ruijie(config)# nfpp
Ruijie(config-nfpp)# dhcp-guard rate-limit per-src-mac 8
Ruijie(config-nfpp)# dhcp-guard rate-limit per-port 100
```

---



NFPP



## 41.4.10 nfpp dhcp-guard policy

**nfpp dhcp-guard policy { per-src-mac | per-port} rate-limit-pps attack-threshold-pps**

<b>per-src-mac</b>	MAC
<b>per-port</b>	
<i>rate-limit-pps</i>	1 9999
<i>attack-threshold-pps</i>	1 9999

└───┘

└───┘

└───┘

```
Ruijie(config)# interface G 0/1
Ruijie(config-if)# nfpp dhcp-guard policy per-src-mac 3 10
Ruijie(config-if)# nfpp dhcp-guard policy per-port 50 100
```

<b>dhcp-guard attack-threshold</b>	
<b>dhcp-guard rate-limit</b>	
<b>show nfpp dhcp-guard summary</b>	
<b>show nfpp dhcp-guard hosts</b>	
<b>clear nfpp dhcp-guard hosts</b>	

└───┘

10.4	

## 41.5 DHCPv6

## 41.5.1 dhcpv6-guard attack-threshold

**dhcpv6-guard attack-threshold** { **per-src-mac** | **per-port** } *pps*

<b>per-src-mac</b>	MAC
<b>per-port</b>	

	-	-

DHCPv6

NFPP

```
Ruijie(config)# nfpp
Ruijie(config-nfpp)# dhcpv6-guard enable
```

<b>nfpp dhcpv6-guard enable</b>		DHCPv6
<b>show nfpp dhcpv6-guard summary</b>		

	10.4	

### 41.5.3 dhcpv6-guard isolate-period

**dhcpv6-guard isolate-period** {seconds | permanent}

<i>seconds</i>	0	[30, 86400]
<b>permanent</b>		

0

NFPP



<b>show nfpp dhcpv6-guard summary</b>	
<b>show nfpp dhcpv6-guard hosts</b>	
<b>clear nfpp dhcpv6-guard hosts</b>	

└───┘

10.4	

### 41.5.5 dhcpv6-guard monitored-host-limit

**dhcpv6-guard monitored-host-limit** *number*

<i>number</i>	1
	4294967295

└───┘

1000

└───┘

NFPP

└───┘

1000 %ERROR The value that you configured is smaller than current monitored hosts 1000 please clear a part of monitored hosts.

└───┘

% NFPP\_DHCP\_GUARD-4-SESSION\_LIMIT: Attempt to exceed limit of 1000 monitored hosts.

└───┘

Ruijie(config)# **nfpp**  
 Ruijie(config-nfpp)# **dhcp-guard monitored-host-limit 200**

<b>show nfpp dhcpv6-guard summary</b>	



**clear nfpp dhcpv6-guard hosts** [*vlan vid*] [**interface** *interface-id*] [*mac-address*]



|

|

DHCPv6

DHCP

|

```
Ruijie(config)# interface G0/1
Ruijie(config-if)# nfpp dhcpv6-guard enable
```

|

dhcpv6-guard enable	DHCPv6
show nfpp dhcpv6-guard summary	

|

|

10.4	

### 41.5.9 nfpp dhcpv6-guard isolate-period

**nfpp dhcpv6-guard isolate-period {seconds | permanent}**

|

--	--	--

seconds c<17EA35D9>1 Tf 0.0001 Tc 7.1412 T- 2 3198 -0.0 ( )Tj ET [30, 86400]0 1 Tf 0 Tc 0 Tw 25.

	<b>dhcpv6-guard isolate-period</b>	
	<b>show nfpp dhcpv6-guard summary</b>	

└───

--	--



-	-

### 41.6.2 icmp-guard enable

ICMP

**icmp-guard enable**

-	-

ICMP

NFPP

```
Ruijie(config)# nfpp
Ruijie(config-nfpp)# icmp-guard enable
```

<b>nfpp icmp-guard enable</b>	ICMP
<b>show nfpp icmp-guard summary</b>	

-	-

### 41.6.3 icmp-guard isolate-period

**icmp-guard isolate-period** {seconds | permanent}

--	--

<i>seconds</i>	0	[30, 86400]
<b>permanent</b>	0	

0

NFPP

```
Ruijie(config)# nfpp
Ruijie(config-nfpp)# icmp-guard isolate-period 180
```

<b>nfpp icmp-guard isolate-period</b>	
<b>show nfpp icmp-guard summary</b>	

-	-
---	---

#### 41.6.4 icmp-guard monitor-period

**icmp-guard monitor-period** *seconds*

<i>seconds</i>	[180, 86400]
----------------	--------------

600

NFPP

> 0





exceed limit of 1000

monitored hosts.



## 41.6.8 clear nfpp icmp-guard hosts

**clear nfpp icmp-guard hosts** [*vlan vid*] [**interface** *interface-id*] [*ip-address*]

<i>vid</i>	
<i>interface-id</i>	
<i>ip-address</i>	IP

└───┘

└───┘

└───┘

```

VLAN 1    g 0/1
Ruijie# clear nfpp icmp-guard hosts vlan 1 interface g 0/1

```

<b>icmp-guard attack-threshold</b>	
<b>nfpp icmp-guard policy</b>	
<b>show nfpp icmp-guard hosts</b>	

└───┘

-	-

## 41.6.9 nfpp icmp-guard enable

ICMP

**nfpp icmp-guard enable**

|

ICMP

|

|

ICMP

ICMP

|

```
Ruijie(config)# interface G0/1
Ruijie(config-if)# nfpp icmp-guard enable
```

|

icmp-guard enable	ICMP
show nfpp icmp-guard summary	

|

|

10.4	

### 41.6.10 nfpp icmp-guard isolate-period

**nfpp icmp-guard isolate-period** {seconds | permanent}

|

seconds	0 [30, 86400]
permanent	0

|

|

|

```
Ruijie(config)# interface G 0/1
Ruijie(config-if)# nfpp
```

|



**icmp-guard isolate-period**

	<b>clear nfpp icmp-guard hosts</b>	
	10.4	

## 41.7 ND

### 41.7.1 nd-guard attack-threshold

**nd-guard attack-threshold per-port {ns-na | rs | ra-redirect} pps**

	<b>ns-na</b>	
	<b>rs</b>	
	<b>ra-redirect</b>	
	<i>pps</i>	[1,9999]

```

30          /          30
          /          30
    
```

NFPP

```

Ruijie(config)# nfpp
Ruijie(config-nfpp)# nd-guard attack-threshold per-port ns-na 20
Ruijie(config-nfpp)# nd-guard attack-threshold per-port rs 10
Ruijie(config-nfpp)# nd-guard attack-threshold per-port ra-redirect 10
    
```

	<b>nfpp nd-guard policy</b>	

┌

10.4	

### 41.7.2 nd-guard enable

ND

#### nd-guard enable

-	-

┌

ND

┌

NFPP

┌

```
Ruijie(config)# nfp
Ruijie(config-nfp)# nd-guard enable
```

<b>nfp nd-guard enable</b>	ND
<b>show nfp nd-guard summary</b>	

┌

10.4	

### 41.7.3 nd-guard rate-limit

**nd-guard rate-limit per-port {** **}**



┌

┌ ND

Ruijie(config)# **interface G0/1**  
 Ruijie(config-if)# **nfpp nd-guard enable**

<b>nd-guard enable</b>	ND
<b>show nfpp nd-guard summary</b>	

┌

┌ 10.4

10.4	

### 41.7.5 nfpp nd-guard policy

**nfpp nd-guard policy per-port {ns-na | rs | ra-redirect} rate-limit-pps attack-thresh  
 old-pps**

┌

┌

┌

<b>ns-na</b>	
<b>rs</b>	
<b>ra-redirect</b>	
<i>rate-limit-pps</i>	1 9999
<i>attack-threshold-pps</i>	1 9999

ND snooping

ND snooping

ND snooping

ND guard

800

900

ND guard

ND snooping

ND snooping

```
Ruijie(config)# interface G 0/1
```

```
Ruijie(config-if)# nfpp nd-guard policy per-port ns-na 50 100
```

```
Ruijie(config-if)# nfpp nd-guard policy per-port rs 10 20
```

```
Ruijie(config-if)# nfpp nd-guard policy per-port ra-redirect 10 20
```

```
Ruijie# clear nfpp log
32 log-buffer entries were cleared.
```

<b>show nfpp log</b>	NFPP

10.4	

### 41.8.2 log-buffer entries

NFPP

**log-buffer entries** *number*

<i>number</i>	[0,1024]

256

NFPP

```
NFPP 50
Ruijie(config)# nfpp
Ruijie(config-nfpp)# log-buffer entries 50
```

<b>log-buffer logs</b> number_of_message interval length_in_seconds	NFPP
<b>show nfpp log</b>	NFPP

└──

└──

10.4	

### 41.8.3 log-buffer logs

NFPP

**log-buffer logs** *number\_of\_message interval length\_in\_seconds*

<i>number_of_message</i>	0-1024 0
<i>length_in_seconds</i>	0-86400 1 0
	<i>number_of_message</i> <i>length_in_seconds</i> 0 <i>number_of_message /length_in_second</i>

10.4	

### 41.8.4 logging

NFPP            VLAN

**logging vlan** *vlan-range*

**logging interface** *interface-id*

<i>vlan-range</i>	VLAN 1-3,5
<i>interface-id</i>	



NFPP

VLAN

```

                VLAN 1  VLAN 2  VLAN 3  VLAN 5
Ruijie(config)# nfpp
Ruijie(config-nfpp)# logging vlan 1-3,5

                G 0/1
Ruijie(config)# nfpp
Ruijie(config-nfpp)# logging interface G 0/1
    
```

<b>show nfpp log summary</b>	NFPP



10.4	



-----

10.4

## 41.9 ARP

### 41.9.1 show nfpp arp-guard hosts

**show nfpp arp-guard hosts** [**statistics** | [[*vlan vid*] [**interface** *interface-id*] [*ip-address* | *mac-address*]]]

<b>statistics</b>	
<i>vid</i>	
<i>interface-id</i>	
<i>ip-address</i>	IP
<i>mac-address</i>	MAC

```

1
Ruijie# show nfpp arp-guard hosts statistics
success  fail    total
-----  ----  -----
100      20     120
          120          100          20

```

```

2
          remain-time(seconds)
Ruijie# show nfpp arp-guard hosts
If column 1 shows '*', it means "hardware do not isolate user" .
VLAN  interface IP address  MAC address  remain-time(s)
----  -
1     Gi0/1     1.1.1.1     -            110
2     Gi0/2     1.1.2.1     -            61
*3    Gi0/3     -           0000.0000.1111 110

```

```

4      Gi0/4      -      0000.0000.2222  61
Total  4 hosts

```

<b>clear nfpp arp-guard hosts</b>	

-	-

### 41.9.2 show nfpp arp-guard scan

ARP

**show nfpp arp-guard scan** [**statistics** | [[**vlan** *vid*] [**interface** *interface-id*] [*ip-address* s] [*mac-address*]]]

<b>statistics</b>	ARP
<i>vid</i>	
<i>interface-id</i>	
<i>ip-address</i>	IP
<i>mac-address</i>	MAC

```
Ruijie# show nfpp arp-guard scan statistics
```

```
ARP scan table has 4 record(s).
```

```

      ARP      4

```

```
Ruijie# show nfpp arp-guard scan
```

```
VLAN      interface      IP address      MAC address      timestamp
```

```

-----
1      Gi0/1      N/A      0000.0000.0001  2008-01-23
16:23:10
2      Gi0/2      1.1.1.1  0000.0000.0002  2008-01-23
16:24:10
3      Gi0/3      N/A      0000.0000.0003  2008-01-23
16:25:10
4      Gi0/4      N/A      0000.0000.0004  2008-01-23
16:26:10
Total 4 record(s)

```

```

timestamp                ARP                2008-01-23 16:23:10
2008  1  23  16  23  10                ARP

```

```

Ruijie# show nfpp arp-guard scan vlan 1 interface G 0/1
0000.0000.0001
VLAN   interface  IP address  MAC address  timestamp
-----
1      Gi0/1      N/A        0000.0000.0001  2008-01-23
16:23:10
Total 1 record(s)

```

<b>arp-guard scan-threshold</b>	
<b>nfpp arp-guard scan-threshold</b>	
<b>clear nfpp arp-guard scan</b>	ARP

-	-

### 41.9.3 show nfpp arp-guard summary

**show nfpp arp-guard summary**

-	-

```
Ruijie# show nfpp arp-guard summary
```

```
Format of column Rate-limit and Attack-threshold is per-src-ip
/per-src-mac/per-port.
```

Interface	Status	Isolate-period	Rate-limit	Attack-threshold	Scan-threshold
Global	Enable	300	4/5/60	8/10/100	15
Gi 0/1	Enable	180	5/-/-	8/-/-	-
Gi 0/2	Disable	200	4/5/60	8/10/100	20

```
Maximum count of monitored hosts: 1000
```

```
Monitor period 300s
```

1	Interface	Global			
2	Status				
3	Rate-limit		IP	/	MAC
/			Attack-threshold		-

<b>arp-guard attack-threshold</b>	
<b>arp-guard enable</b>	ARP
<b>arp-guard isolate-period</b>	
<b>arp-guard monitor-period</b>	
<b>arp-guard monitored-host-limit</b>	
<b>arp-guard rate-limit</b>	
<b>arp-guard scan-threshold</b>	
<b>nfpp arp-guard enable</b>	ARP
<b>nfpp arp-guard isolate-period</b>	

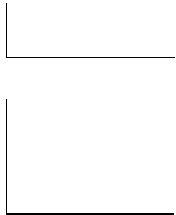

-	-

## 41.10 DHCP

### 41.10.1 show nfpp dhcp-guard hosts

**show nfpp dhcp-guard hosts** [**statistics** | [[**vlan** *vid*] [**interface** *interface-id*] [*mac-address*]]]

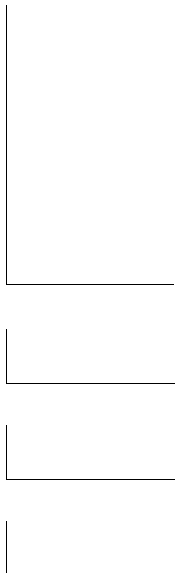

<b>statistics</b>	
<i>vid</i>	
<i>interface-id</i>	
<i>mac-address</i>	MAC

Ruijie# **show nfpp dhcp-guard hosts statistics**

```

success   fail   total
-----   ----   -----
100       20     120
          120         100           20
    
```

remain-time(seconds)

Ruijie# **show nfpp dhcp-guard hosts**

If column 1 shows '\*', it means "hardware failed to isolate host".

```

VLAN   interface   MAC address   remain-time(seconds)
    
```

```

-----
1    gi0/2    0000.0000.0001    10
*2  gi0/1    0000.0000.0002    20
Total 2 host(s)

```

<b>clear nfpp dhcp-guard hosts</b>	

10.4	

### 41.10.2 show nfpp dhcp-guard summary

**show nfpp dhcp-guard summary**

-	-

```

Ruijie# show nfpp dhcp-guard summary

Format of column Rate-limit and Attack-threshold is per-src-ip
/per-src-mac/per-port.

Interface Status Isolate-period Rate-limit Attack-threshold
Global    Enable  300          -/5/150    -/10/300
Gi 0/1    Enable  180          -/6/-      -/8/-
Gi 0/2    Disable 200          -/5/30     -/10/50

Maximum count of monitored hosts: 1000
Monitor period 300s

```

```

1      Interface  Global
2      Status
3      Rate-limit          IP          /      MAC
/          Attack-threshold          -
    
```

<b>dhcp-guard attack-threshold</b>	
<b>dhcp-guard enable</b>	DHCP
<b>dhcp-guard isolate-period</b>	
<b>dhcp-guard monitor-period</b>	
<b>dhcp-guard monitored-host-limit</b>	
<b>dhcp-guard rate-limit</b>	
<b>nfpp dhcp-guard enable</b>	DHCP
<b>nfpp dhcp-guard isolate-period</b>	
<b>nfpp dhcp-guard policy</b>	

10.4	

## 41.11 DHCPv6

### 41.11.1 show nfpp dhcpv6-guard hosts

```
show nfpp dhcpv6-guard hosts [statistics | [[vlan vid] [interface interface-id6W 78.31j/.o.e2Gd0(6
```

<i>mac-address</i>	MAC
--------------------	-----

Ruijie# **show nfpp dhcpv6-guard hosts statistics**

success	fail	total
-----	----	-----
100	20	120
	120	100
		20

remain-time(seconds)

Ruijie# **show nfpp dhcpv6-guard hosts**

If column 1 shows '\*', it means "hardware failed to isolate host".

VLAN	interface	MAC address	remain-time(seconds)
----	-----	-----	-----
1	gi0/2	0000.0000.0001	10
*2	gi0/1	0000.0000.0002	20
Total	2 host(s)		

-	-

Ruijie# **show nfpp dhcpv6-guard summary**

Format of column Rate-limit and Attack-threshold is per-src-ip /per-src-mac/per-port.

<b>Interface</b>	<b>Status</b>	<b>Isolate-period</b>	<b>Rate-limit</b>	<b>Attack-threshold</b>
Global	Enable	300	-/5/150	-/10/300
Gi 0/1	Enable	180	-/6/-	-/8/-
Gi 0/2	Disable	200	-/5/30	-/10/50

Maximum count of monitored hosts: 1000

Monitor period 300s

1	Interface	Global		
2	Status			
3	Rate-limit		IP / MAC	
	/		Attack-threshold	-



	10.4	

## 41.12 ICMP

### 41.12.1 show nfpp icmp-guard hosts

```

2      Gi0/2      1.1.2.1      61
Total  2 host(s)

```

<b>clear nfpp icmp-guard hosts</b>	

10.4	

### 41.12.2 show nfpp icmp-guard summary

**show nfpp icmp-guard summary**

-	-

```
Ruijie# show nfpp icmp-guard summary
```

```

Format of column Rate-limit and Attack-threshold is per-src-ip
/per-src-mac/per-port.

```

Interface	Status	Isolate-period	Rate-limit	Attack-threshold
Global	Enable	300	4/-/60	8/-/100
Gi 0/1	Enable	180	5/-/-	8/-/-
Gi 0/2	Disable	200	4/-/60	8/-/100

```
Maximum count of monitored hosts: 1000
```

```
Monitor period 300s
```

```
1      Interface  Global
```

```

2      Status
3      Rate-limit          IP          /      MAC          /
                          Attack-threshold          -
    
```

<b>icmp-guard attack-threshold</b>	
<b>icmp-guard enable</b>	ICMP
<b>icmp-guard isolate-period</b>	
<b>icmp-guard monitor-period</b>	
<b>icmp-guard monitored-host-limit</b>	
<b>icmp-guard rate-limit</b>	
<b>nfpp icmp-guard enable</b>	ICMP
<b>nfpp icmp-guard isolate-period</b>	
<b>nfpp icmp-guard policy</b>	

10.4	

### 41.12.3 show nfpp icmp-guard trusted-host

**show nfpp icmp-guard trusted-host**

-	-

```
Ruijie# show nfpp icmp-guard trusted-host
IP address      mask
-----
1.1.1.0         255.255.255.0
```

```

Gi 0/1      Enable 15/15/15 30/30/30
Gi 0/2      Disable -/5/30  -/10/50
    
```

```

1      Interface  Global
2      Status
3      Rate-limit          /          /
      /          /          Attack-threshold
      -
      -/5/30          G 0/2          /
      5              /              30
    
```

<b>nd-guard attack-threshold</b>	
<b>nd-guard enable</b>	ND
<b>nd-guard rate-limit</b>	
<b>nfpp nd-guard enable</b>	ND
<b>nfpp nd-guard policy</b>	

--	--

# 42 ACL

id	IP ACL 1-99 1300-1999 IP ACL 100-199 2000-2699 MAC ACL 700-799 ACL 2700-2899
name	ACL
sn	ACL ( )
start-sn	
inc-sn	
deny	
permit	
prot	IPv6 ipv6 icmp tcp udp 0-255 IPv4 eigrp gre ipinip igmp nos ospf icmp udp

inc

eigrp È

È

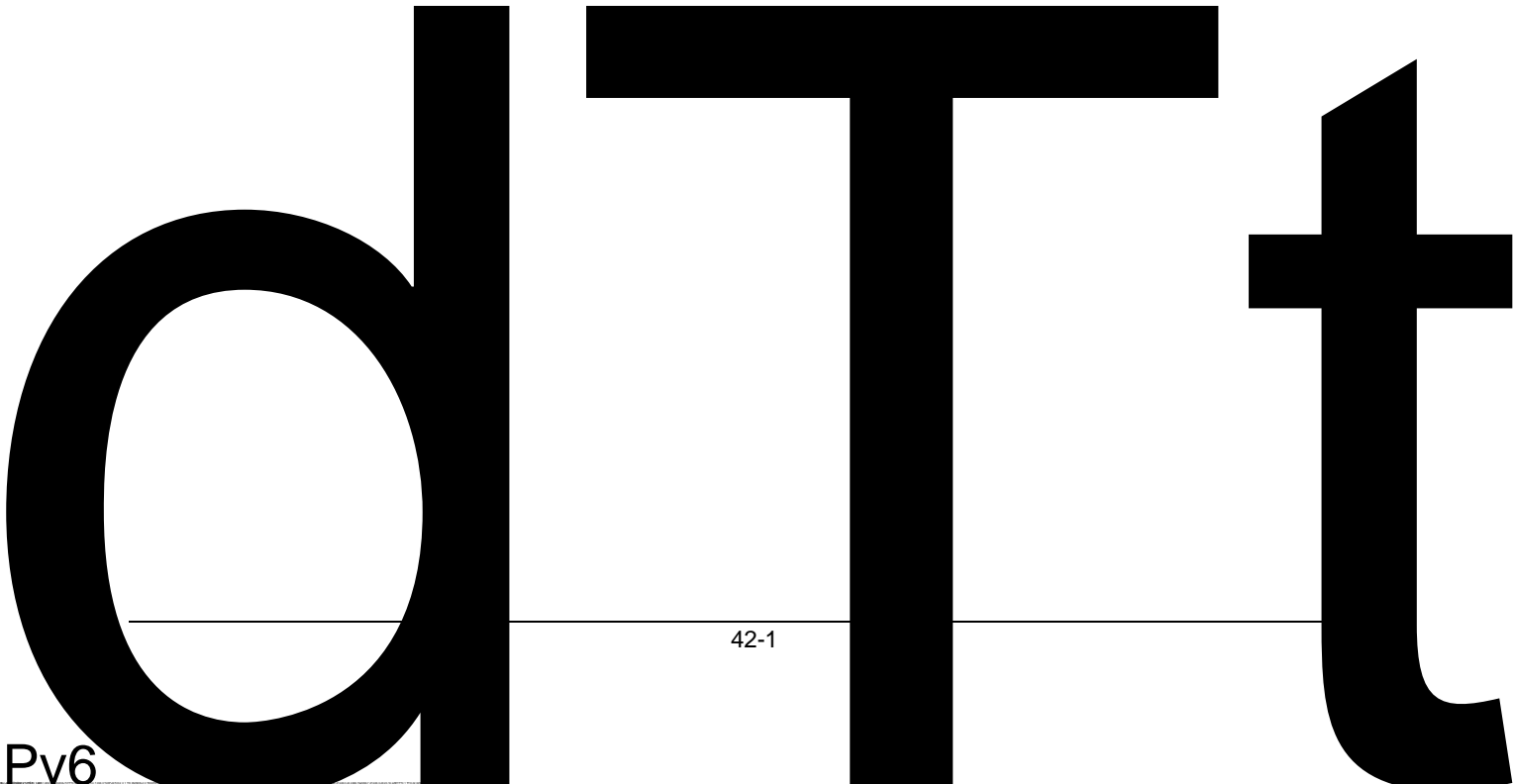

precedence precedence	0-7
range	
time-range tm-rng-name	tm-rng-name
tos tos	0-15
cos cos	cos (0-7)
cos inner cos	tag cos
icmp-type	ICMP 0-255
icmp-code	ICMP 0-255
icmp-message	ICMP
operator port[port]	Operator lt- eq- gt- neq- range- port

B	MAC	6	P		35
C		12	Q	IP	36
D	VLAN tag	14	R	ip	38
E	DSAP( )	18	S	ip	42
F	SSAP( )	19	T	TCP	46
G	Ctrl	20	U	TCP	48
H	Org Code	21	V		50
I	=	i t ~ ]	s	x t	

## 4) Expert 2700 - 2899

**access-list** *id* {deny | permit} [protocol | [ethernet-type][ cos [out][ inner in]]] [VID [out][inner in]] {source source-wildcard | host source | any} {host source-mac-address | any} {destination destination-wildcard | host destination | any} {host destination-mac-address | any} [[precedence precedence] [tos tos] [fragments] [range lower upper] [time-range time-range-name]

> Ethernet-type cos

**access-list** *id* {deny | permit} {ethernet-type} cos [out][ inner in]] [VID [out][inner in]] {source source-wildcard | host source | any} {host source-mac-address | any } {destination destination-wildcard | host destination | any} {host destination-mac-address | any} [time-range time-range-name]

> Protocol

**access-list** *id* {deny | permit} protocol [VID [out][inner in]] {source source-wildcard | host source | any} {host source-mac-address | any } {destination destination-wildcard | host destination | any} {host destination-mac-address | any} [precedence precedence] [tos tos] [fragments] [range lower upper] [time-range time-range-name]

> Expert

**Internet Control Message Protocol (ICMP)**

**access-list** *id* {deny | permit} icmp [VID [out][inner in]] {source source-wildcard | host source | any} {host source-mac-address | any } {destination destination-wildcard | host destination | any} {host destination-mac-address | any} [ icmp-type ] [ [ icmp-type [icmp-code ] ] | [ icmp-message ] ] [precedence precedence] [tos tos] [fragments] [time-range time-range-name]

**Transmission Control Protocol (TCP)**

**access-list** *id* {deny | permit} tcp [VID [out][inner in]] {source source-wildcard | host Source | any} {host source-mac-address | any } [operator port [port] ] {destination destination-wildcard | host destination | any} {host destination-mac-address | any} [operator port [port] ] [precedence precedence] [tos tos] [fragments] [range lower upper] [time-range time-range-name] [match-all tcp-flag]

**User Datagram Protocol (UDP)**

**access-list** *id* {deny | permit} udp [VID [out][inner in]] {source source -wildcard | host source | any} {host source-mac-address | any } [ operator port [port] ] {destination destination-wildcard | host destination | any}{host destination-mac-address | any} [operator port [port] ] [precedence precedence] [tos tos] [fragments] [range lower upper] [time-range time-range-name]

## 5)

**access-list** *list-remark text*

<i>Id</i>	1-99 100-199 1300-1999 2000-2699 2700 – 2899 700 - 799
<b>Deny</b>	
<b>Permit</b>	
<i>Source</i>	
<i>source-wildcard</i>	0.255.0.32
<i>protocol</i>	IP EIGRP GRE IPINIP IGMP NOS OSPF ICMP UDP TCP IP IP 0-255 ICMP/TCP/UDP
<i>Destination</i>	
<i>destination-wildcard</i>	0.255.0.32
<b>fragments</b>	

precedence 0.0 Tc 0.98<01C3D9.4SPF XE\$

<b>match-all</b>	<i>tcp flag</i>
<i>tcp-flag</i>	tcp flag

ACL

**access-list**

- › dod-host-prohibited
- › dod-net-prohibited
- › echo
- › echo-reply
- › fragment-time-exceeded
- › general-parameter-problem
- › host-isolated
- › host-precedence-unreachable
- › host-redirect
- › host-tos-redirect
- › host-tos-unreachable
- › host-unknown
- › host-unreachable
- › information-reply
- › information-request
- › mask-reply
- › mask-request
- › mobile-redirect
- › net-redirect
- › net-tos-redirect
- › net-tos-unreachable
- › net-unreachable
- › network-unknown
- › no-room-for-option
- › option-missing
- › packet-too-big
- › parameter-problem
- › port-unreachable
- › precedence-unreachable
- › protocol-unreachable
- › redirect
- › router-advertisement
- › router-solicitation
- › source-quench
- › source-route-failed
- › time-exceeded
- › timestamp-reply
- › timestamp-request

```
>  ttl-exceeded
>  unreachable
      TCP          TCP
>  bgp
>  chargen
>  cmd
>  daytime
>  discard
>  domain
>  echo
>  exec
>  finger
>  ftp
>  ftp-data
>  gopher
>  hostname
>  ident
>  irc
>  klogin
>  kshell
>  login
>  nntp
>  pim-auto-rp
>  pop2
>  pop3
>  smtp
>  sunrpc
>  syslog
>  tacacs
>  talk
>  telnet
>  time
>  uucp
>  whois
>  www
      UDP          UDP
>  biff
>  bootpc
```

- › bootps
- › discard
- › dnsix
- › domain
- › echo
- › isakmp
- › mobile-ip
- › nameserver
- › netbios-dgm
- › netbios-ns
- › netbios-ss
- › ntp
- › pim-auto-rp
- › rip
- › snmp
- › snmptrap
- › sunrpc
- › syslog
- › tacacs
- › talk
- › tftp
- › time
- › who
- › xdmcp

## Ethernet-type

- › aarp
- › arp
- › appletalk
- › decnet-iv
- › diagnostic
- › etype-6000
- › etype-8042
- › lat
- › lavc-sca
- › mop-console
- › mop-dump
- › mumps
- › netbios

- > vines-echo
- > xns-idp

```
1 IP
   IP          192.168.1.64 - 192.168.1.127
```

```
Ruijie(config)# access-list 1 permit 192.168.1.64 0.0.0.63
```

```
2 IP
   IP          DNS      ICMP
```

```
Ruijie(config)# access-list 102 permit tcp any any eq domain
```

```
Ruijie(config)# access-list 102 permit udp any any eq domain
```

```
Ruijie(config)# access-list 102 permit icmp any any echo
```

```
Ruijie(config)# access-list 102 permit icmp any any echo-reply
```

```
3 MAC
   MAC 00d0f8000c0c          100
```

## 42.1.2 deny

```
1 IP (deny)
   {
[sn] deny {source source-wildcard 1
```

```
[sn] d{ } [(s)-8((s)8(72/0)5.000717300091 T6-(0)70128(1)3)4/026 37038(1)3110495240
```

*destination-wildcard* | **host** *destination* | **any** {**host** *destination-mac-address* | **any**}  
**[time-range** *time-range-name*]

b) protocol

[*sn*] **deny protocol** [[**VID** [*out*][*inner in*]]] {*source source-wildcard* | **host source** | **any**}  
 {**host source-mac-address** | **any**} {*destination destination-wildcard* | **host destination** | **any**}  
 {**host destination-mac-address** | **any**} [**precedence precedence**] [**tos tos**] [**fragments**]  
**[range lower upper]** [~~**time-range**~~ *name*]

c) expert

> **Internet Control Message Protocol (ICMP)**

[*sn*] **deny icmp** [[**VID** [*out*][*inner in*]]] {*source source-wildcard* | **host source** | **any**} {**host**  
*source-mac-address* | **any**} {*destination destination-wildcard* | **host destination** | **any**} {**host**  
*destination-mac-address* | **any**} [*icmp-type*] [[*icmp-type icmp-code* ]] | [*icmp-message*]]  
**[precedence precedence]** [**tos tos**] [**frag-6( )**]931 Tf0(upper)c 0 Tw 2.571 0 Td[(icmp)-65 Tf2BE3C02D6>T/TT0 1 Tf

[[*icmp-type* [*icmp-code*]] | [*icmp-message*]] [**dscp** *dscp*] [**flow-label** *flow-label*] [**fragments**] [**time-range** *time-range-name*]

› **Transmission Control Protocol (TCP)**

[*sn*] **deny tcp** {*source-ipv6-prefix* / *prefix-length* | **host** *source-ipv6-address* | **any**}[*operator* **port**[*port*]] {*destination-ipv6-prefix* /*prefix-length* | **host** *destination-ipv6-address* | **any**} [*operator* **port** [*port*]] [**dscp** *dscp*] [**flow-label** *flow-label*] [**fragments**] [**range** *lower upper*] [**time-range** *time-range-name*] [**match-all** *tcp-flag*]

› **User Datagram Protocol (UDP)**

[*sn*] **deny udp** {*source-ipv6-prefix/prefix-length* | **host** *source-ipv6-address* | **any**} [*operator* **port** [*port*]] {*destination-ipv6-prefix* /*prefix-length* | **host** *destination-ipv6-address* | **any**}[*operator* **port** [*port*]] [**dscp** *dscp*] [**flow-label** *flow-label*] [**fragments**] [**range** *lower upper*] [**time-range** *time-range-name*]

<i>Sn</i>	ACL
<i>source-ipv6-prefix</i>	IPv6
<i>destination-ipv6-prefix</i>	IPv6
<i>prefix-length</i>	
<i>source-ipv6-address</i>	IPv6
<i>destination-ipv6-address</i>	IPv6
<b>dscp</b>	
<i>dscp</i>	0-63.
<b>flow-label</b>	
<i>flow-label</i>	0-1048575
<i>protocol</i>	IPV6 <0-255> IPV6   icmp   tcp   udp

IPV6



1

```
Ruijie(config)# ipv6 access-list extended v6-acl
Ruijie(config-ipv6-nacl)# 11 deny ipv6 host 192.168.4.12 any
Ruijie(config-ipv6-nacl)# show access-lists
ipv6 access-list extended v6-acl
11 deny ipv6 host 192.168.4.12 any
Ruijie(config-ipv6-nacl)# exit
Ruijie(config)# interface gigabitethernet 1/1
Ruijie(config-if)# ipv6 traffic-filter v6-acl in
```

<b>show access-lists</b>	
<b>ipv6 traffic-filter</b>	IPV6
<b>ip access-group</b>	IP ACL
<b>mac access-group</b>	MAC ACL
<b>ip access-list</b>	IP ACL
<b>mac access-list</b>	MAC ACL
<b>expert access-list</b>	ACL
<b>ipv6 access-list</b>	IPV6 ACL
<b>permit</b>	

V10.0	V10.0 arp V10.2(3)
-------	-----------------------

### 42.1.3 expert access-group

EXPERT ACL

no

**expert access-group** {id | name} {in | out}

**no expert access-group** {id | name} {in | out}

<i>id</i>	Expert	2700-2899
<i>name</i>	Expert	

ACL

**show expert access-lists**

```

1          ACL
Ruijie(config)# expert access-list extended exp-acl
Ruijie(config-exp-nacl)# show expert access-lists
expert access-list extended exp-acl
Ruijie(config-exp-nacl)#

2          ACL
Ruijie(config)# expert access-list extended 2704
Ruijie(config-exp-nacl)# show expert access-lists
expert access-list extended 2704
Ruijie(config-exp-nacl)#
    
```

<b>show expert access-lists</b>	

V10.0	V10.0

### 42.1.5 ip access-group

**ip access-group**                      no

**ip access-group** {*id* | *name*} {**in** | **out**}

**no ip access-group** { *id* | *name*} {**in** | **out**}

<i>id</i>	IP                      1-199    1300-2699
<i>name</i>	IP
<b>in</b>	
<b>out</b>	

**ip access-group**

fastEthernet0/0 120

Ruijie(config)# **interface fastEthernet 0/0**

Ruijie(config-if)#**ip access-group 120 in**

<b>access-list</b>	
<b>show access-lists</b>	
<b>show ip access-list</b>	IP 1-199 1300 - 2699 3000 3199

```

1      ACL
Ruijie(config)# ip access-list standard std-acl
Ruijie(config-std-nacl)# show ip access-lists
ip access-list standard std-acl
Ruijie(config-std-nacl)#

2      ACL
Ruijie(config)# ip access-list extended 123
Ruijie(config-ext-nacl)# show ip access-lists
ip access-list extended 123
    
```

<b>show ip access-lists</b>	IP

V10.0	V10.0

### 42.1.7 ip access-list resequence

```

ip      ACL          IPV6    ACL
no
    
```

**ip access-list resequence {id | name} start-sn inc-sn**

**no ip access-list resequence {id | name}**

<i>id</i>	ACL
<i>name</i>	ACL
<i>start-sn</i>	
<i>inc-sn</i>	

```

start-sn 10
inc-sn 10
    
```



**show access-lists**

ACL  
Ruijie#

|

|

ACL  
traffic-filter

show ipv6

|

```

access-list v6-acl Gigabit 1
Ruijie(config)# interface GigaEthernet 0/1
Ruijie(config-if)# ipv6 traffic-filter v6-acl in
    
```

|

show access-group	ACL

|

|

V10.0	V10.0

### 42.1.9 ipv6 access-list

|

IPV6 ACL

no

ACL

ipv6 access-list *name*

no ipv6 access-list *name*

|

<i>name</i>	ACL

|

|

|

show access-lists

|

```

IPV6 ACL
Ruijie(config)# ipv6 access-list v6-acl
Ruijie(config-ipv6-nacl)# show access-lists
ipv6 access-list extended v6-acl
Ruijie(config-ipv6-nacl)#
    
```

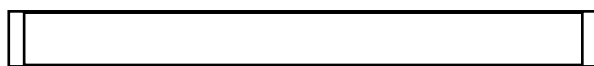

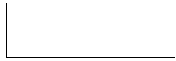

V10.0	V10.0

### 42.1.11 MAC access-group

MAC ACL

no

**mac access-group** {*id* | *name*}{*in* | *out*}

**no mac access-group** {*id* | *name*} {*in* | *out*}



<i>id</i>	MAC 700-799
<i>name</i>	MAC
<b>in</b>	
<b>out</b>	

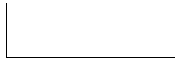

ACL



**show running-config**



```

access-list accept_00d0f8xxxxx_only Gigabit 1 interfac8ef4B21 Tf11
Ruijie(config)# interface GigaEthernet 1/1
Ruijie(config-if)# mac access-group accept_00d0f8xxxxx_only in
    
```

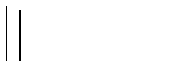

--	--

**show access-group**

ACL

MAC ACL

no

ACL

**mac access-list extended** {*id* | *name*}

**no mac access-list extended** {*id* | *name*}

<i>id</i>	MAC	700-799
<i>name</i>	MAC	

MAC ACL

**show mac access-lists**

1 MAC ACL

Ruijie(config)# **mac access-list extended** *mac-acl*

Ruijie(config-mac-nacl)# **show mac access-lists**

mac access-list extended *mac-acl*

2 MAC ACL

Ruijie(config)# **mac access-list extended** 704

Ruijie(config-mac-nacl)# **show mac access-lists**

mac access-list extended 704

<b>show mac access-lists</b>	mac

V10.0	V10.0

### 42.1.13 no sn

ACL

no *sn*

--	--

---

<i>sn</i>	ACL
-----------	-----

---

ACL

ACL

ACL

```
Ruijie(config)# ipv6 access-list extended v6-acl
Ruijie(config-ipv6-nacl)# permit ipv6 host ::192.168.4.12 any
Ruijie(config-ipv6-nacl)# 12 deny ipv6 host any any
Ruijie(config-ipv6-nacl)# show access-lists
ipv6 access-list extended v6-acl
10 permit ipv6 host ::192.168.4.12 any
12 deny ipv6 any any
Ruijie(config-ipv6-nacl)# no 12
Ruijie(config-ipv6-nacl)# show access-lists
ipv6 access-list extended v6-acl
10 permit ipv6 host ::192.168.4.12 any
Ruijie(config-ipv6-nacl)#
```

## 1) IP

```
[sn] permit {source source-wildcard | host source | any}
```

## 2) IP

```
[sn] permit protocol source source-wildcard destination destination-wildcard [precedence  
precedence] [tos tos] [fragments] [range lower upper] [time-range time-range-name]
```

IP

## › Internet Control Message Protocol (ICMP)

```
[sn] permit icmp {source source-wildcard | host source | any} {destination  
destination-wildcard | host destination | any} [ icmp-type ] [[icmp-type [icmp-code ]] |  
[ icmp-message ]] [precedence precedence] [tos tos] [fragments] [time-range  
time-range-name]
```

## › Transmission Control Protocol (TCP)

```
[sn] permit tcp {source source-wildcard | host source | any} [destination destination-wildcard | host destination | any] [destination-port destination-port] [source-port source-port] [time-range time-range-name]
```

[sn] **permit protocol** [VID [out][inner in]] {source source-wildcard | **host** Source | **any**} {**host** source-mac-address | **any**} {destination destination-wildcard | **host** destination | **any**} {**host** destination-mac-address | **any**} [precedence precedence] [tos tos] [fragments] [range lower upper] [time-range time-range-name]

Expert

› **Internet Control Message Protocol (ICMP)**

[sn] **permit icmp** [VID [out][inner in]] {source source-wildcard | **host** source | **any**} {**host** source-mac-address | **any**} {destination destination-wildcard | **host** destination | **any**} {**host** destination-mac-address | **any**} [icmp-type ] [[icmp-type [icmp-code ]] | [ icmp-message ]] [precedence precedence] [tos tos] [fragments] [time-range time-range-name]

› **Transmission Control Protocol (TCP)**

[sn] **permit tcp** [VID [out][inner in]] {source source-wildcard | **host** Source | **any**} {**host** source-mac-address | **any**} [operator port [port]] {destination destination-wildcard | **host** destination | **any**} {**host** destination-mac-address | **any**} [operator port [port]] [precedence precedence] [tos tos] [fragments] [range lower upper] [time-range time-range-name] [match-all tcp-flag]

› **User Datagram Protocol (UDP)**

[sn] **permit udp** [VID [out][inner in]] {source source-wildcard | **host** source | **any**} {**host** source-mac-address | **any**} [ operator port [port]] {destination destination-wildcard | **host** destination | **any**} {**host** destination-mac-address | **any**} [operator port [port]] [precedenceprecedence] [tos tos] [fragments] [range lower upper] [time-range time-range-name]

› **Address Resolution Protocol (ARP)**

[sn] **permit arp** {vid vlan-id} [host source-mac-address | **any**] [host destination-mac-address | **any**] {sender-ip sender-ip-wildcard | **host** sender-ip | **any**} {sender-mac sender-mac-wildcard | **host** sender-mac | **any**} {target-ip target-ip-wildcard | **host** target-ip | **any**}

5) IPV6

[sn] **permit protocol** {source-ipv6-prefix / prefix-length | **any** | **host** source-ipv6-address} {destination-ipv6-prefix / prefix-length | **any**} {hostdestination-ipv6-address} [dscp dscp] [flow-label flow-label] [fragments] [range lower upper] [time-range time-range-name]

IPV6

› **Internet Control Message Protocol (ICMP)**

[sn] **permit icmp** {source-ipv6-prefix / prefix-length | **any** source-ipv6-address | **host**} {destination-ipv6-prefix / prefix-length | **host** destination-ipv6-address | **any**} [icmp-type] [[icmp-type [icmp-code]] | [icmp-message]] [dscp dscp] [flow-label flow-label][fragments] [time-range time-range-name]

› **Transmission Control Protocol (TCP)**

[sn] **permit tcp** {*source-ipv6-prefix / prefix-length* | **host** *source-ipv6-address* | **any**}  
[*operator* **port** [*port*]] {*destination-ipv6-prefix / prefix-length* | **host** *destination-ipv6-address*  
| **any**} [*operator* **port** [*port*]] [**dscp** *dscp*] [**flow-label** *flow-label*] [**fragments**] [**range** *lower*  
*upper*] [**time-range** *time-range-name*] [**match-all** *tcp-flag*]

› **User Datagram Protocol (UDP)**

[sn] **permit udp** {*source-ipv6-prefix / prefix-length* | **host** *source-ipv6-address* | **any**}  
[*operator* **port** [*port*]] {*destination-ipv6-prefix / prefix-length* | **host** *destination-ipv6-address*  
| **any**} [*operator* **port** [*port*]] [**dscp** *dscp*] [**flow-label** *flow-label*] [**fragments**] [**range** *lower*  
*upper*] [**time-range** *time-range-name*]



```
Ruijie(config)# interface gigabitethernet 1/1
Ruijie(config-if)# ip access-group 102 in
Ruijie(config-if)#
    3      MAC      ACL              MAC  0013.0049.8272
      100              1
Ruijie(config)# mac access-list extended 702
Ruijie(config-mac-nacl)# permit host 0013.0049.8272 any aarp
Ruijie(config-mac-nacl)# show access-lists
mac access-list extended
10 permit host 0013.0049.8272 any aarp702
Ruijie(config-mac-nacl)# exit
Ruijie(config)# interface gigabitethernet 1/1
Ruijie(config-if)# mac access-group 702 in
    4      ip      ACL              IP  192.168.4.12
      1
Ruijie(config)# ip access-list standard std-acl
Ruijie(config-std-nacl)# permit host 192.168.4.12
Ruijie(config-std-nacl)# show access-lists
ip access-list standard std-acl
10 permit host 192.168.4.12
Ruijie(config-std-nacl)# exit
Ruijie(config)# interface gigabitethernet 1/1
Ruijie(config-if)# ip access-group std-acl in
    5      IPV6      ACL              IP  192.168.4.12
      1
Ruijie(config)# ipv6 access-list extended v6-acl
Ruijie(config-ipv6-nacl)# 11 permit ipv6
host ::192.168.4.12 any
Ruijie(config-ipv6-nacl)# show access-lists
ipv6 access-list extended v6-acl
11 permit ipv6 host 192.168.4.12 any
Ruijie(config-ipv6-nacl)# exit
Ruijie(config)# interface gigabitethernet 1/1
Ruijie(config-if)# ip access-group 102 in
```

<b>ip access-group</b>	IP ACL
<b>mac access-group</b>	MAC ACL
<b>ip access-list</b>	IP ACL
<b>mac access-list</b>	MAC ACL
<b>expert access-list</b>	ACL
<b>ipv6 access-list</b>	IPV6 ACL
<b>deny</b>	ACL

V10.0	V10.0 arp V10.2(3)
-------	-----------------------

## 42.2

### 42.2.1 show access-group

ACL

**show access-group** [interface <interface>]

<interface>	
-------------	--

ACL

ACL

```
Ruijie# show access-group
ip access-list standard ipstd3
Applied On interface GigabitEthernet 0/1.
ip access-list standard ipstd4
Applied On interface GigabitEthernet 0/2.
ip access-list extended 101
```

```
Applied On interface GigabitEthernet 0/3.
ip access-list extended 102
Applied On interface GigabitEthernet 0/8.
```

<b>ip access-group</b>	ip
<b>mac access-group</b>	MAC
<b>expert access-group</b>	Expert
<b>ipv6 traffic-filter</b>	IPV6

V10.0	V10.0

### 42.2.2 show access-lists

ACL                      ACL

**show access-lists** [*id* | *name*]

<i>id</i>	
<i>name</i>	

acl                      *id*   *name*                      ACL

```
Ruijie# show access-lists n_acl
ip access-list standard n_acl
Ruijie# show access-lists 102
ip access-list extended 102
Ruijie# show access-lists
ip access-list standard n_acl
```

ACL

|

V10.0	V10.0

### 42.2.4 show ip access-group

IP ACL

**show ip access-group**[interface <interface>]

<interface>	

|

|

|

IP ACL

IP ACL

```
Ruijie# show ip access-group interface gigabitethernet 0/1
ip access-group aaa in
Applied On interface GigabitEthernet 0/1.
```

<b>ip access-list</b>	IP ACL

|

	<code>&lt;interface&gt;</code>	

|

|

|

IPv6 ACL

IPv6 ACL

|

```
Ruijie# show ipv6 traffic-filter interface gigabitethernet 0/4  
ipv6 traffic-filter v6 in  
Applied On interface GigabitEthernet 0/4.
```

|

--	--	--

```
mac access-group mm in
Applied On interface GigabitEthernet 0/3.
```

<b>mac access-list</b>		MAC	ACL

V10.0		V10.0	

## 42.3

### 42.3.1 security access-group

**security access-group** {*id*|*name*}

**no security access-group**

<i>id</i>		ACL id	
<i>name</i>		ACL	

```
Ruijie(config-if)#security access-group 1
```

<b>show secu-acl</b>			

---

	V10.2	V10.2

### 42.3.2 security global access-group

**security global access-group** {*id*|*name*}

**no security global access-group**

--	--	--



Fa0/6      uplink      --

<b>security global access-group</b>	
<b>security access-group</b>	
<b>security uplink enable</b>	

V10.2	V10.2

# 43 QOS

## 43.1

```

QoS
>
> policy-map
> class-map
> class-map 1 ACL ACL ACE
> ACE "ACL"
QoS Policy Map
QoS QOS Policy Map Off
QoS
-----
CoS | 0
-----
    | 8
-----
    | WRR A

```

<b>CoS to DSCP</b>	<b>CoS</b>	<b>DSCP</b>
	0	0
	1	8
	2	16
	3	24
	4	32
	5	40
	6	48
	7	56

## IP-Precedence to DSCP

<b>IP-Precede nce to DSCP</b>	<b>IP-Precedence</b>	<b>DSCP</b>
	0	0
	1	8
	2	16
	3	24
	4	32
	5	40
	6	48
	7	56

## DSCP to CoS

<b>DSCP to CoS</b>	<b>DSCP</b>	<b>CoS</b>
	0	0
	8	1
	16	2
	24	3
	32	4
	40	5
	48	6
	56	7

## 43.2

### 43.2.1 class maps

ACL

**ip access-list** {**extended** | **standard**} { *acl-id* | *acl-name* }

**mac access-list extended** {*acl-id* | *acl-name*}

**expert access-list extended** {*acl-id* | *acl-name*}

**ipv6 access-list extended** *acl-name*

```
4      class-map,   cm
Ruijie(config)# class-map cm
5      ACL
Ruijie(config-cmap)# match access-group me
6      class-map
Ruijie(config-cmap)# exit
```

---





	-	-
--	---	---

### 43.2.4 mls qos cos

CoS

**mls qos cos** *default-cos*

**no mls qos cos**

<i>default-cos</i>		0 7
<b>no</b>		

CoS 0

```
Ruijie(config)# interface gigabitethernet 1/1
Ruijie(config-if)# mls qos cos 7
```

<b>show mls qos interface</b> <i>interface-id</i>		-

	<b>dscp</b>	
	<b>no</b>	

|

|

|

| Ruijie(config)# **mls qos map cos-dscp 8 10 16 18 24 26 32 34**

```
Ruijie(config)# mls qos mls qos
```

## 43.2.8 mls qos scheduler

**mls qos scheduler [sp | rr | wrr | drr]**

**no mls qos scheduler**



<b>cos</b>	Qos	CoS
<b>dscp</b>	Qos	DSCP

<i>policy-map-name</i>	polycymap
<b>no policy-map</b> <i>policy-map-name</i>	policy map
<i>class-map-name</i>	class map
<b>no class</b> <i>class-map-name</i>	
<i>new-dscp</i>	DSCP
<i>rate-bps</i>	kbps
<i>burst-byte</i>	kbyte
<i>drop</i>	
<i>dscp-value</i>	DSCP

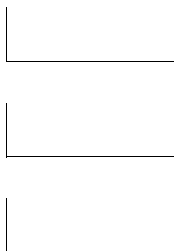

```

1      policy map,   po
Ruijie(config)# policy-map po
2      class-map cm
Ruijie(config-pmap)# class cm
3      dscp      10
Ruijie(config-pmap-c)# set ip dscp 10
4      1M,      4096k,      dscp 16
Ruijie(config-pmap-c)# police 1000000 4096 exceed-action dscp 16
    
```

<b>show policy-map</b>	-
------------------------	---



-	-
---	---

### 43.2.11 priority-queue

[no] priority-queue

priority-queue	SP
no priority-queue	WRR

WRR

E

!

8

|

|

|

|

Ruijie(config)# **priority-queue cos-map 1 0 1**

|

<b>show mls qos queueing</b>	-

|

|

-	-

### 43.2.13 service-policy

policy map

**service-policy** {input | output} *policy-map-name*

**no service-policy** {input | output}

|

<i>policy-map-name</i>	polycymap
<b>no</b>	policy map

|

|

|

|

Ruijie(config)# **interface fastEthernet 0/1**

Ruijie(config-if)# **service-policy input po**

|

--	--



**show policy-map** [*policy-name* [**class** *class-name*]]

<i>policy-name</i>	policy name
<i>class-name</i>	class map

policy name

Ruijie# **show policy-map**

-	-

-	-

### 43.3.3 show mls qos interface

QoS

**show mls qos interface** *interface-id* [**policers**]

<i>interface-id</i>	
<b>policers</b>	police

QoS

```
Ruijie# show mls qos interface fastEthernet 0/1
```

-	-

-	-

### 43.3.4 show mls qos maps

dscp-cos maps, dscp-cos maps ip-prec-dscp maps

**show mls qos maps [cos-dscp | dscp-cos | ip-prec-dscp]**

<b>cos-dscp</b>	cos-dscp maps
<b>dscp-cos</b>	dscp-cos maps
<b>ip-prec-dscp</b>	ip-prec-dscp maps

dscp-cos maps dscp-cos maps ip-prec-dscp maps

```
Ruijie# show mls qos maps
```

-	-

-	-

### 43.3.5 show mls qos queueing

QoS (cos-to-queue map,wrr weight,drr weight)

**show mls qos queueing**



Ruijie# **show mls qos rate-limit**

-	-

-	-

### 43.3.7 show mls qos scheduler

**show mls qos scheduler**

-	-

Ruijie# **show mls qos scheduler**

-	-

-

-	-

# 44 Voice VLAN

## 44.1

### 44.1.1 voice vlan

```

Voice VLAN
Voice VLAN
voice vlan vlan-id
no voice vlan
    
```

<i>vlan-id</i>	Voice VLAN ID
----------------	---------------

```

```

	Voice VLAN	Voice VLAN ID
1	Voice VLAN	VLAN
2	VLAN 1 VLAN	VLAN 1 Voice
3	VLAN	Voice VLAN Super VLAN
4		802.1x VLAN VID Voice VLAN ID
5	RSPAN VLAN	Remote VLAN Voice VLAN 1 Voice VLAN

```

1 Voice VLAN VLAN2 Voice VLAN
Ruijie(config)# vlan 2
Ruijie(config-vlan)# exit
Ruijie(config)# voice vlan 2
    
```

--	--

**show voice vlan**

Voice VLAN  
44-2



	<i>dscp-value</i>	Voice VLAN	DSCP
	<i>dscp-value</i>	46	
		Voice VLAN	CoS DSCP
	1	Voice VLAN	DSCP 40
	Ruijie(config)# <b>voice vlan dscp 40</b>		
	<b>show voice vlan</b>	Voice VLAN	
	10.4		

### 44.1.5 voice vlan enable

	Voice VLAN	Voice VLAN	<b>no</b>
	<b>voice vlan enable</b>		
	<b>no voice vlan enable</b>		



```
1      OUI      0012.3400.0000  Voice VLAN      Company A
Ruijie(config)# voice vlan mac-address 0012.3400.0000 mask
                ffff.ff00.0000 description Company A
```

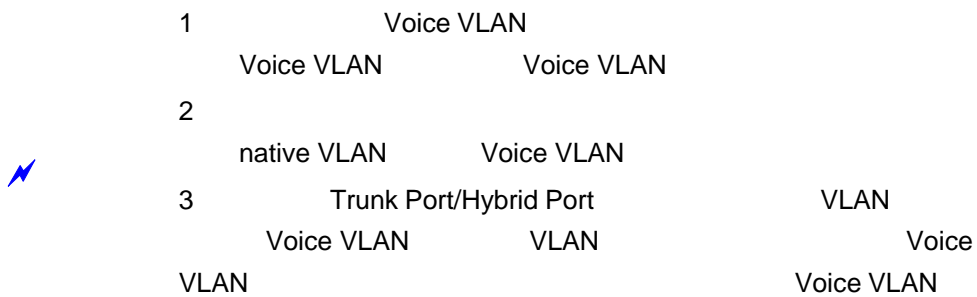

Voice VLAN OUI	MAC	MAC
	Voice VLAN	
	Voice VLAN	
	untagged	Voice VLAN tag
	MAC VLAN	Voice VLAN tag Voice VLAN /

1 Voice VLAN  
Ruijie(config)# voice vlan security enable

<b>show voice vlan</b>	Voice VLAN

[Redacted]

|

Voice VLAN

Voice VLAN

```

1          Voice VLAN
Ruijie(config)# show voice vlan
Voice VLAN status: ENABLE           //Voice VLAN
Voice VLAN ID: 2                     //Voice VLAN ID
Voice VLAN security mode: Security //
Voice VLAN aging time: 5 minutes    //
Voice VLAN cos: 6                    //      CoS
Voice VLAN dscp: 46                  //      DSCP
Current voice vlan enabled port mode: //      Voice VLAN
PORT                                MODE
-----
Fa0/1                                Auto
    
```

<b>voice vlan</b> <i>vlan-id</i>	Voice VLAN VLAN	Voice VLAN
<b>voice vlan aging</b> <i>minutes</i>	Voice VLAN	
<b>voice vlan cos</b> <i>cos-value</i>	Voice VLAN	CoS
<b>voice vlan dscp</b> <i>dscp-value</i>	Voice VLAN	DSCP
<b>voice vlan enable</b>	Voice VLAN	
<b>voice vlan mode auto</b>	Voice VLAN	
<b>voice vlan security enable</b>	Voice VLAN	

10.4	

### 44.2.2 show voice vlan oui

OUI      OUI

**show voice vlan oui**

Voice VLAN

---

--	--	--

└───

└───



# 46 RLDP

## 46.1

### 46.1.1 rldp detect-interval

RLDP

**rldp detect-interval** *interval*

**no rldp detect-interval**

	<i>interval</i>	2-15

3

stp × stp

5s :  
Ruijie(config)# **rldp detect-interval** 5

	<b>rldp detect-max</b>	

	-	-

### 46.1.2 rldp detect-max

RLDP

**rldp detect-max** *num*

**no rldp detect-max**

<i>num</i>	,	2-10

2

5  
Ruijie(config)# **rldp detect-max 5**

<b>rldp detect-interval</b>	

-	-

### 46.1.3 rldp enable

RLDP

**rldp enable**

**no rldp enable**

	RLDP	RLDP
	Ruijie(config)# <b>rldp enable</b>	
	<b>rldp port</b>	
	-	

### 46.1.4 rldp port

rldp

**rldp port { unidirection-detect | bidirection-detect | loop-detect | shutdown-svi | shutdown-port | block }**

**no rldp port { unidirection-detect | bidirection-detect | loop-detect }**

	<b>unidirection-detect</b>	
	<b>bidirection-detect</b>	
	<b>loop-detect</b>	
	<b>warning</b>	
	<b>shutdown-svi</b>	shutdown svi

```
Ruijie(config)# interface fas 0/1
Ruijie(config-if)# rldp port loop-detect block
```

<b>rldp enable</b>	rldp

-	-

### 46.1.5 rldp reset

**rldp shutdown    disable                    rldp**

**rldp reset**

-	-

```
Ruijie# rldp reset
```

<b>rldp enable</b>	Rldp

-	-

## 46.2

### 46.2.1 show rldp

rldp

**show rldp** [**interface** *interface-id*]

--	--

└──

└── EXEC

└──

└──

└──

-	-

└──

└──

-	-

# 47 TPP

## 47.1

### 47.1.1 topology guard

topology guard

no

[no] topology guard

	-	-

no

**[no] tp-guard port enable**



|

|

tpp

|

Ruijie# **show tpp**

|

<b>topology guard</b>	

|

|

-	-

---

# 48

## 48.1

### 48.1.1 cd

`cd [filesystem:][directory]`

	<i>filesystem</i>	
	<i>directory</i>	

flash

cd / pwd

1 usb0  
Ruijie# **cd** usb0:/  
2 sd  
Ruijie# **cd** sd0:/

	pwd	

## 48.1.2 copy

**copy** *source-url destination-url*

<i>source-url</i>	URL
<i>destination-url</i>	URL

copy

URL

<b>flash:</b>	flash URL flash
<b>tftp:</b>	TFTP
<b>xmodem:</b>	xmodem
<b>slave:</b>	flash
<b>usb0:</b>	usb
<b>usb1:</b>	usb
<b>sd0:</b>	sd



URL

1 tftp

```

Ruijie#copy tftp://192.168.201.54/rgos.bin flash:/
  2          tftp
Ruijie#copy flash:/rgos.bin tftp://192.168.201.54/rgos.bin
  3          xmodem
Ruijie# copy xmodem: flash:/config.text
  4          U
Ruijie#copy flash:/config.text usb0:/config.text
  5
Ruijie#copy flash:/config.text slave:/config.text
  6          flash      sd
Ruijie#copy flash:/rgos.bin sd0:/rgos.bin
  7          U          sd
Ruijie#copy usb0:/config.text sd0:/config.text
  8          sd          U
Ruijie#copy sd0:/config.text usb0:/config.text

```

<b>del</b>	
<b>rename</b>	
<b>dir</b>	

### 48.1.3 delete

#### delete url

<i>url</i>	<i>url</i>



url



1

Ruijie# **dir** slave0:/

Directory of slave:/

Mode	Link	Size	MTime	Name
1		10838016	2008-01-01 00:01:53	rgos.bin
1		399	2008-01-01 00:01:37	config.text
1		399	2008-01-01 00:17:58	cfg.txt

3 Files (Total size 11210782 Bytes), 0 Directories.

Total 33030144 bytes (31MB) in this device, 20463616 bytes (19MB) available.

2

Ruijie# **dir**

Directory of temp:/

Mode	Link	Size	MTime	Name
1		399	2008-01-01 00:17:58	a.dat

1 Files (Total size 399 Bytes), 0 Directories.

Total 33030144 bytes (31MB) in this device, 20463616 bytes (19MB) available.

<b>pwd</b>	
<b>cd</b>	



---

---

## 48.1.6 rename

**rename** *url1 url2*

<i>url1</i>	URL
<i>url2</i>	URL

usb0/1, flash, slave

1 log.txt

**48.1.7 rmdir**

*rmdir directory*

<i>directory</i>		,

└──

└──

└──

└──  
 Ruijie# **rmdir** tmp

<b>mkdir</b>		

└──

**48.2**

**48.2.1 pwd**

---

**pwd**

└─

└─

└─

└─  
1  
Ruijie# **pwd**  
**flash:/**

<b>cd</b>	

└─

## 48.2.2 show file systems

**show file systems**

└─

---

└──

└──

└──

1  
Ruijie#show file systems

└──

└──

└──

---

# 49

## 49.1 CPU

### 49.1.1 cpu-log

CPU , **cpu-log**  
**cpu-log** *log-limit low\_num high\_num*

---

	-	-

	-	-

### 49.1.2 show cpu

	CPU	show cpu
show cpu		
	-	-

┌

┌

┌

	CPU	CPU	5	1	5
	CPU		5	1	5
	CPU	p			1

---

5	0%	0%	0%	waitqueue_process
6	0%	0%	0%	tasklet_task
7	0%	0%	0%	kevents
8	0%	0%	0%	snmpd
9	0%	0%	0%	snmp_trapd
10	0%	0%	0%	mtdblock
11	0%	0%	0%	gc_task
12	0%	0%	0%	Context
13	0%	0%	0%	kswapd
14	0%	0%	0%	bdflush
15	0%	0%	0%	kupdate
16	0%	3%	1%	ll_mt
17	0%	0%	0%	ll main process
18	0%	0%	0%	bridge_relay
19	0%	0%	0%	dlx_task
20	0%	0%	0%	secu_policy_task
21	0%	0%	0%	dhcpa_task
22	0%	0%	0%	dhcpsnp_task
23	0%	0%	0%	igmp_snp
24	0%	0%	0%	mstp_event
25	0%	0%	0%	GVRP_EVENT
26	0%	0%	0%	rldp_task
27	0%	2%	1%	rerp_task
28	0%	0%	0%	reup_event_handler
29	0%	0%	0%	tpp_task
30	0%	0%	0%	ip6timer
31	0%	0%	0%	rtadvd
32	0%	0%	0%	tnet6
33	2%	0%	0%	tnet
34	0%	0%	0%	Tarptime
35	0%	0%	0%	gra_arp
36	0%	0%	0%	Ttcptimer
37	8%	1%	0%	ef_res
38	0%	0%	0%	ef_rcv_msg
39	0%	0%	0%	ef_inconsistent_daemon
40	0%	0%	0%	ip6_tunnel_rcv_pkt
41	0%	0%	0%	res6t
42	0%	0%	0%	tunrt6
43	0%	0%	0%	ef6_rcv_msg

---

---

44	0%	0%	0%	ef6_inconsistent_daemon
45	0%	0%	0%	imid
46	0%	0%	0%	nsmd
47	0%	0%	0%	ripd
48	0%	0%	0%	ripngd
49	0%	0%	0%	ospfd
50	0%	0%	0%	ospf6d
51	0%	0%	0%	bgpd
52	0%	0%	0%	pimd
53	0%	0%	0%	pim6d
54	0%	0%	0%	pdmd
55	0%	0%	0%	dvmrpd
56	0%	0%	0%	vty_connect
57	0%	0%	0%	aaa_task
58	0%	0%	0%	Tlogtrap
59	0%	0%	0%	dhcp6c
60	0%	0%	0%	sntp_recv_task
61	0%	0%	0%	ntp_task
62	0%	0%	0%	sla_daemon
63	0%	3%	1%	track_daemon
64	0%	0%	0%	pbr_guard
65	0%	0%	0%	vrrpd
66	0%	0%	0%	psnps
67	0%	0%	0%	igsnpd
68	0%	0%	0%	coa_recv
69	0%	0%	0%	co_oper
70	0%	0%	0%	co_mac
71	0%	0%	0%	radius_task
72	0%	0%	0%	tac+_acct_task
73	0%	0%	0%	tac+_task
74	0%	0%	0%	dhcpd_task
75	0%	0%	0%	dhcps_task
76	0%	0%	0%	dhcpping_task
77	0%	0%	0%	dhcpc_task
78	0%	0%	0%	uart_debug_file_task
79	0%	0%	0%	ssp_init_task
80	0%	0%	0%	rl_listen
81	0%	0%	0%	ikl_msg_operate_thread
82	0%	0%	0%	bcmDPC

---

83	0%	0%	0%	bcmL2X.0	
84	3%	3%	3%	bcmL2X.0	
85	0%	0%	0%	bcmCNTR.0	
86	0%	0%	0%	bcmTX	
87	0%	0%	0%	bcmXGS3AsyncTX	
88	0%	2%	1%	bcmLINK.0	
89	0%	0%	0%	bcmRX	
90	0%	0%	0%	mngpkt_rcv_thread	
91	0%	0%	0%	mngpkt_recycle_thread	
92	0%	0%	0%	stack_task	
93	0%	0%	0%	stack_disc_task	
94	0%	0%	0%	redun_sync_task	
95	0%	0%	0%	conf_dispatch_task	
96	0%	0%	0%	devprob_task	
97	0%	0%	0%	rdp_snd_thread	
98	0%	0%	0%	rdp_rcv_thread	
99	0%	0%	0%	rdp_slot_change_thread	
100	4%	2%	1%	datapkt_rcv_thread	
101	0%	0%	0%	keepalive_link_notify	
102	0%	0%	0%	rerp_msg_rcv_thread	
103	0%	0%	0%	ip_scan_guard_task	
104	0%	0%	0%	ssp_ipmc_hit_task	
105	0%	0%	0%	ssp_ipmc_trap_task	
106	0%	0%	0%	hw_err_snd_task	
107	0%	0%	0%	rerp_packet_send_task	
108	0%	0%	0%	idle_vlan_proc_thread	
109	0%	0%	0%	cmic_pause_detect	
110	1%	1%	1%	stat_get_and_send	
111	0%	1%	0%	rl_con	
112	75%	80%	90%	idle	
		3	5	1	5
	CPU	LISR	HISR		CPU

No	
5Sec	5 CPU
1Min	1 CPU
5Min	5 CPU

---

2

,X

---

bgp

---

/

---

1 BGP  
Ruijie(config)# **memory-lack exit-policy bgp**

<b>show memory</b>	

-

10.3(4b3)	

## 49.2.2 show memory

**show memory**

**show memory**

-	-

└───

└───

---

Free pages: 1079

watermarks : min 379, lower 758, low 1137, high 1516

System Total Memory : 128MB, Current Free Memory : 5283KB

Used Rate : 96%

1. 4k

2.

min	
lower	<b>memory-lack exit-policy</b>
low	OVERFLOW

high

OVERFLOW



---

# 50

## 50.1

### 50.1.1 clear logging

clear logging

	-	-

|

|

|

|

Ruijie# clear logging

	logging on	
	show logging	
	logging buffered	

|

---

**more flash:filename**

<i>Filename</i>	

└──

└──

FLASH

"//f2" "//f3"

<i>levell</i>	0 7
---------------	-----

4k Bytes  
7

**show logging**

clear logging  
FLASH

Syslog Server

8

Emergencies	0	
Alerts	1	
Critical	2	
Errors	3	
warnings	4	
Notifications	5	
informational	6	
Debugging	7	

0

6 6 10000

Ruijie(config)# **logging buffered 10000 6**

<b>logging on</b>	
<b>show logging</b>	
<b>clear logging</b>	

	-	-

### 50.1.4 logging console

no

**logging console level**

**no logging console**

		0 7
<i>level</i>		1

Debugging (7)

**show logging**

6  
Ruijie(config)# **logging console informational**

	<b>logging on</b>	
	<b>show logging</b>	

	-	-

---

## 50.1.5 logging count

no

**logging count**

**no logging count**

	-	-

|

|

|

**no logging count**

|

Ruijie(config)# **logging count**

	<b>show logging count</b>	
	<b>show logging</b>	

|

	-	-

<i>facility-type</i>	Syslog
----------------------	--------

Local7(23)

2 Syslog

Numerical Code	Facility
0	kernel messages
1	user-level messages
2	mail system
3	system daemons
4	security/authorization messages
5	messages generated internally by syslogd
6	line printer subsystem
7	network news subsystem
8	UUCP subsystem
9	clock daemon
10	security/authorization messages
11	FTP daemon
12	NTP subsystem
13	log audit
14	log alert
15	clock daemon
16	local use 0 (local0)
17	local use 1 (local1)
18	local use 2 (local2)
19	local use 3 (local3)
20	local use 4 (local4)
21	local use 5 (local5)
22	local use 6 (local6)
23	local use 7 (local7)

(local7) 23

Syslog kernel

Ruijie(config)# logging facility kern

logging console	

-	-

### 50.1.7 logging file flash

FLASH

FLASH

no

logging file flash:filename [max-file-size] [level]

no logging file

Filename	txt
max-file-size	128K 6M bytes
level	FLASH 6
	1

FLASH

Syslog Server

FLASH

txt



FLASH  
FLASH logging file flash

FLASH

---

VTY

6

Ruijie(config)# **logging monitor informational**

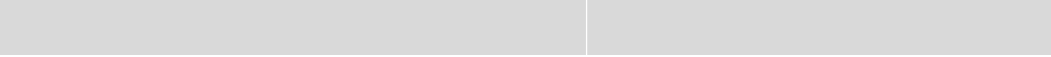

<b>logging</b>	Syslog Server
<b>logging file flash:</b>	FLASH
<b>logging console</b>	
<b>logging monitor</b>	VTY ( telnet )
<b>logging trap</b>	Syslog Server

-	-

### 50.1.10 logging rate-limit

no

**logging rate-limit** {*number* | *all number* | *console* {*number* | *all number*}} [*except severity*]

**no logging rate-limit**

<i>number</i>	1—10000
<i>all</i>	0—7
<i>console</i>	
<i>except</i>	error(3) error
<i>severity</i>	0—7

---

debug 10 warning

Ruijie(config)#**logging rate-limit all 10 except warnings**

<b>show logging count</b>	
<b>show logging</b>	

```

2          IPV6      AAAA:BBBB::FFFF
Ruijie(config)# logging server ipv6 AAAA:BBBB::FFFF

```

<b>logging on</b>	
<b>show logging</b>	
<b>logging trap</b>	syslog server

-	-

### 50.1.12 logging source ip| ipv6

no

**logging source** {ip *ip-address* | **ipv6** *ipv6-address*}

**no logging source** {ip | ipv6}

<i>ip-address</i>	IPV4



	-	-
--	---	---

### 50.1.14 logging synchronous

no

**logging synchronous**

**no logging synchronous**

	-	-

┌  
└  
┌  
└  
┌

```
Ruijie(config)#line console 0
Ruijie(config-line)#logging synchronous
                        UP-DOWN
Ruijie#configure terminal
Oct  9 23:40:55 %LINK-5-CHANGED: Interface GigabitEthernet 0/1,
changed state to down
Oct  9 23:40:55 %LINEPROTO-5-UPDOWN: Line protocol on Interface
GigabitEthernet 0/1, changed state to DOWN
Ruijie# configure terminal //
```

	<b>show running-config</b>	

┌

	-	-

### 50.1.15 logging trap

---

## Syslog Server

---

**service sequence-numbers**

**no service sequence-numbers**

	-	-

|

|

|

1

|

Ruijie(config)# **service sequence-numbers**

	<b>logging on</b>	
	<b>service timestamps</b>	

|

	-	-

### 50.1.17 service sysname

no

**service sysname**

**no service sysname**

	-	-

|

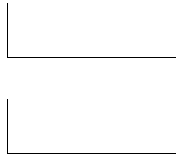

```
Mar 22 15:28:02 %SYS-5-CONFIG: Configured from console by console
Ruijie# config terminal
Enter configuration commands, one per line. End with CNTL/Z.
Ruijie(config)#
```

<i>msec</i>	Jul 27 16:53:07.299
<i>year</i>	2007 Jul 27 16:53:07

RTC

Uptime  
Datetime

Log            Debug            Datetime

```
Ruijie(config)# service timestamps debug datetime msec
Ruijie(config)# service timestamps log datetime msec
Ruijie(config)# end
Ruijie(config)# Oct 8 23:04:58.301 %SYS-5-CONFIG_I: Configured from
console by console
```

<b>logging on</b>	
<b>service sequence-numbers</b>	

-	-

### 50.1.19 terminal monitor

```

VTY
no
terminal monitor
terminal no monitor

```



---

Trap logging	Syslog Server
Log Buffer	
logging on	
clear logging	
-	-

## 50.2.2 show logging count

show logging count

-	-
---	---

```

logging count
show logging

```

```

show logging count
Ruijie# show logging count
Module Name  Message Name Sev Occur      Last Time
=====SYS
CONFIG_I     5  1      Jul 6 10:29:57
-----SYS      TOTAL      1

```

--	--

---

	<b>logging count</b>	
	<b>show logging</b>	
	<b>clear logging</b>	
	-	-

---

---

**51**

<b>member</b> <i>member</i>	ID member 1
<i>description</i>	31

└───

└───

└───

└───

```

write
2 red-giant
Ruijie(config)# device-description member 2 red-giant

```

<b>show member</b>	

└───

-	-

## 51.2

### 51.2.1 show member

**show member** [*member*]

<i>member</i>	ID

└───

└───

└───

---

Ruijie# **show member**