

SATA
POWER



||

||



copyright © 2022

7x24

4008-111-000

1

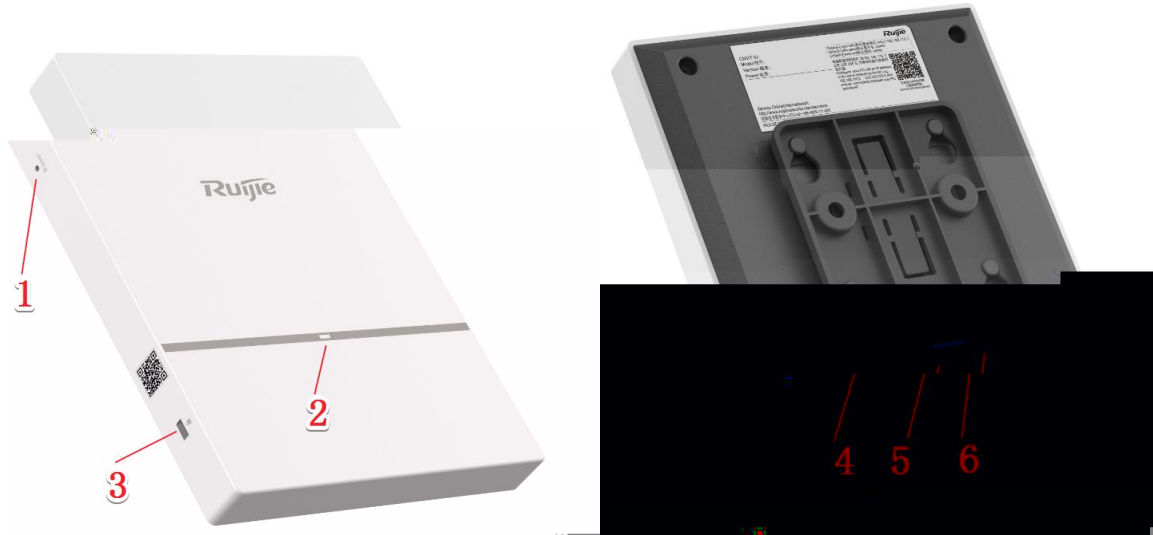

1.3 RG-AP820-L

3Hz		

—		
3Hz		
—		
3Hz	AP	Link down
—		
3Hz		

Hz 1 3Hz 1 3

RG-AP820-L

DC

PoE



2

2.1

RG-AP820-L

2.2

AP

500m

2.3

,

2.4

AP

H ₂ S	0.006	0.03
NO ₂	0.04	0.15
NH ₃	0.05	0.15
Cl ₂	0.01	0.3

2.5.5 EMI

2.6

2.7

--	--

3

RG-AP820-L AP

3.1

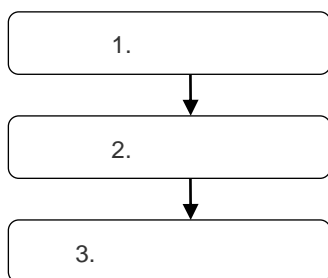

3.2

RG-AP820-L

3.3

AP

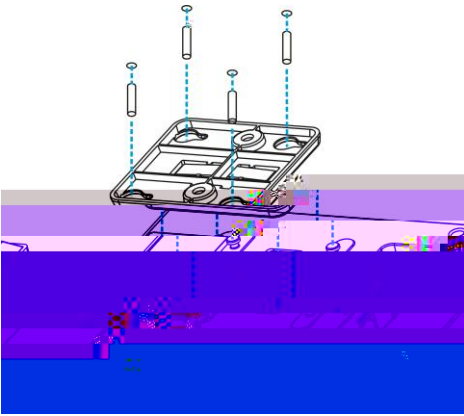

2)

3-3 AP

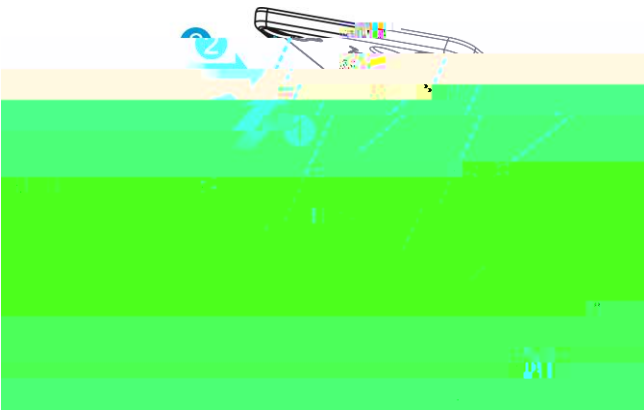

RG-AP820-L

1)

2

6mm

26.5mm

3-4

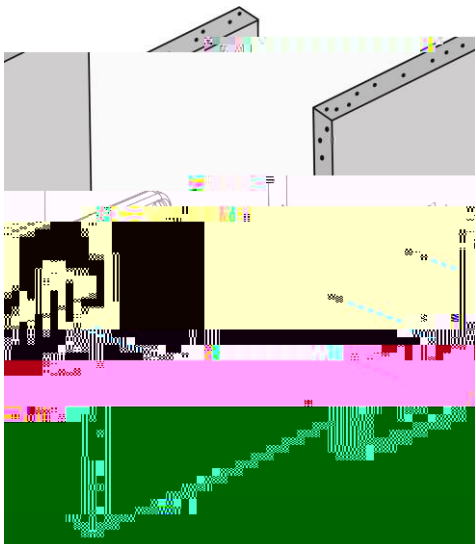

2)

3-5 AP

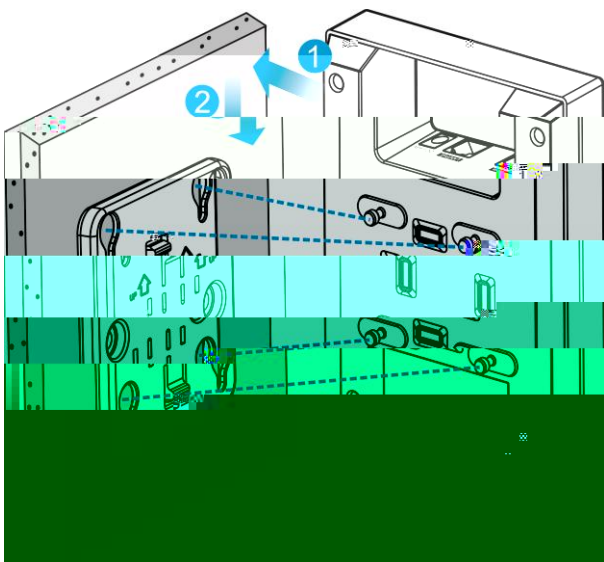

3)

3-6 AP

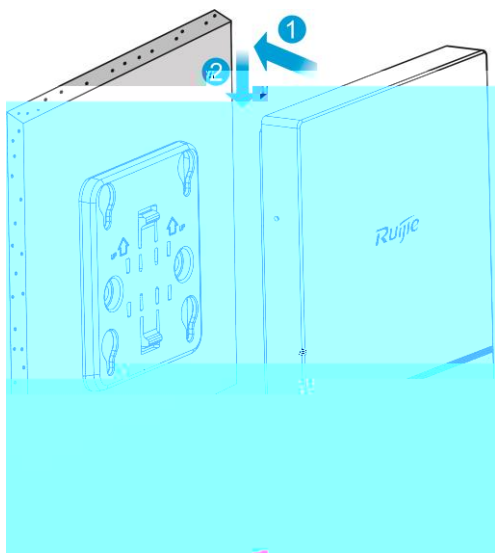

" Ruijie" logo

3.5

1

3-7 AP

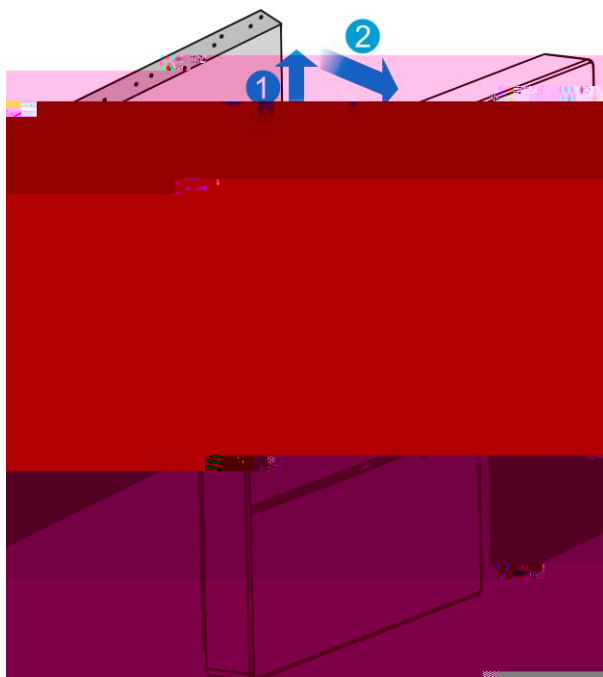

2

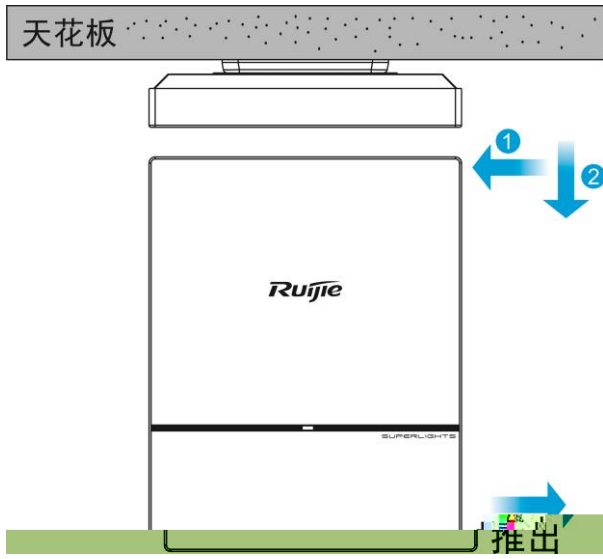

3.6

AP	LAN/PoE	AP		A	
console		9600	8	1	AP

3.7

- 1) LAN/PoE
- 2)
- 3)

3.8

AP

4

4.1

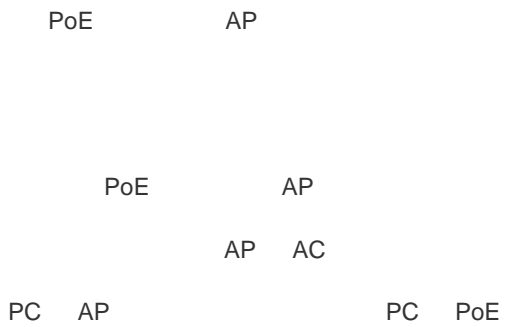

4.2

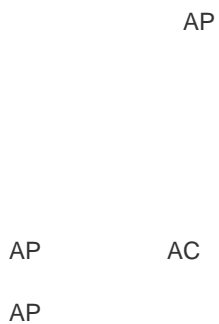

5

5.1

RG-AP820-L

CLI

RG-AP820-L

AC

RG-AP820-L

Telnet

RG-AP820-L

RG-AP820-L

5.2

AP

AP

AP

AP

AP

AC

5.3

6

6.1

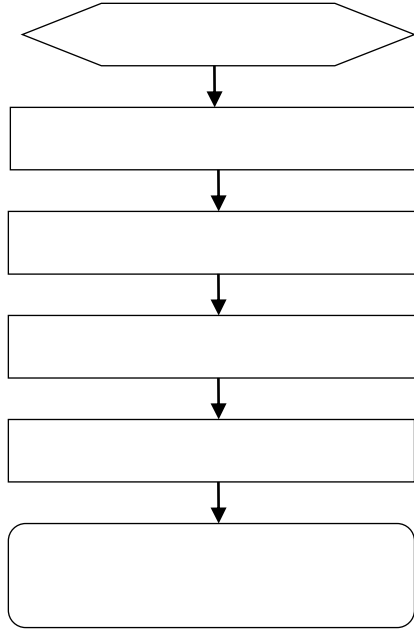

6.2

PoE

PoE

802.11af

AP

1)

1)

2) AP

3)

AP

1

fit

10

AC

AP

AC

CAPWAP

A — —

1000BASE-T/100BASE-TX/10BASE-T

1000BASE-T/100BASE-TX/10BASE-T

MDI/MDIX Crossover

1000BASE-T IEEE 802.3ab
100

100-ohm 5

5

UTP

STP

1000BASE-T 4

4

1000BASE-T

A-1 1000BASE-

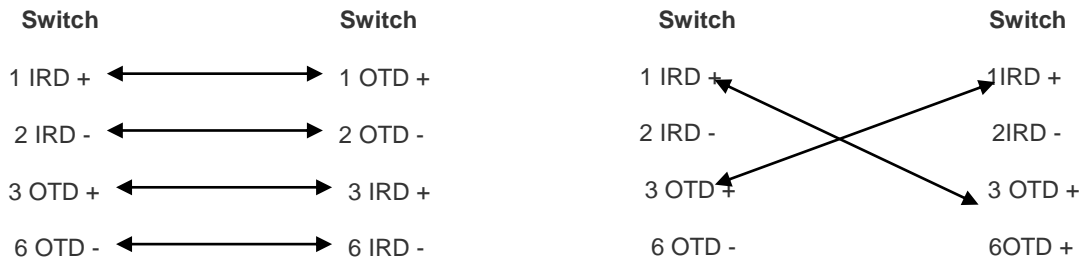

— —

RG-AP820-L

7

5

7

10

SFP+

5

10

D-1

D-1

30mm

D-2

D-2

D-3

D-3

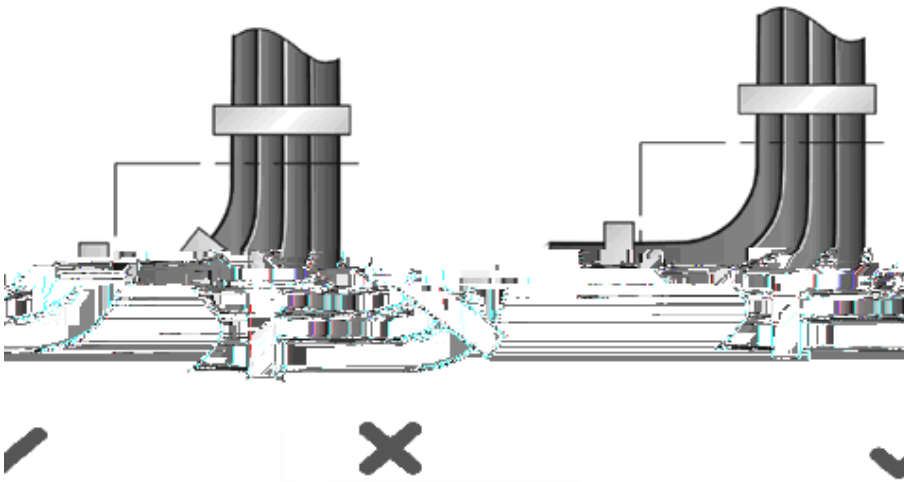

220V

-48V

D-4

D-4

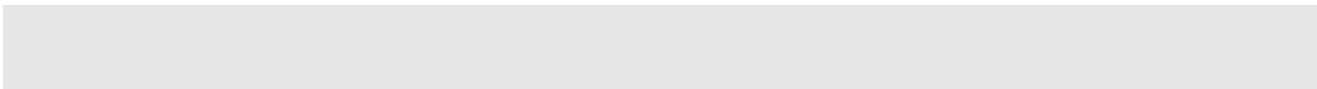
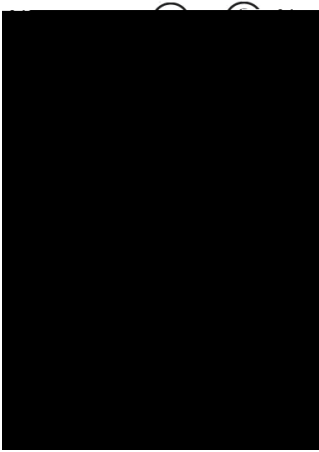

(mm)	(mm)
10	80~150
10~30	150~200
30	200~300

C — —

1		1		
2		1		
3		2		

D — —

- DC48V 0.3A
- DC

2.1mm	5.5mm	10mm	

