

V1.1

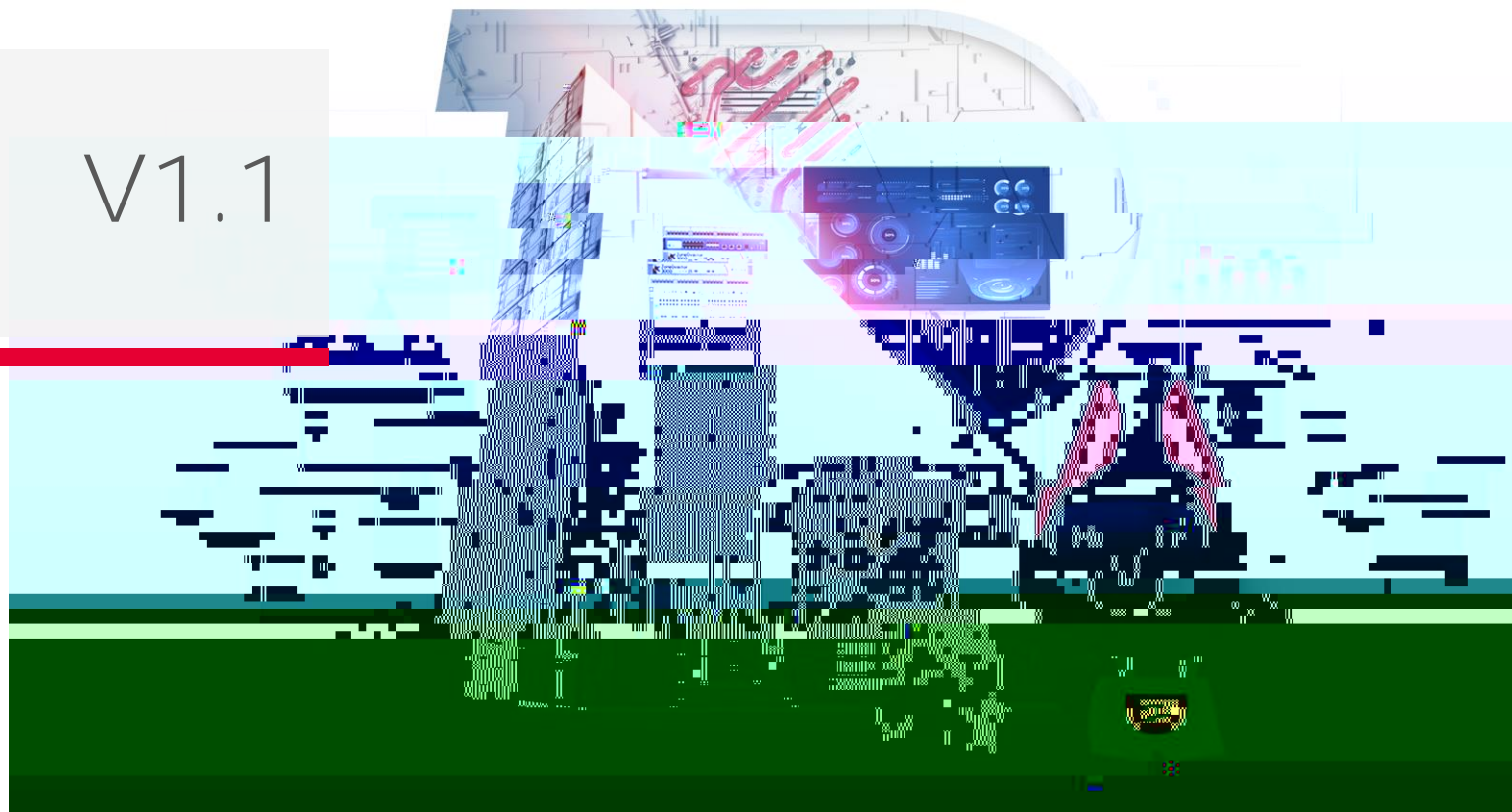

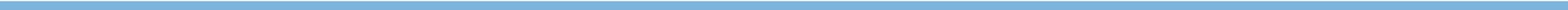

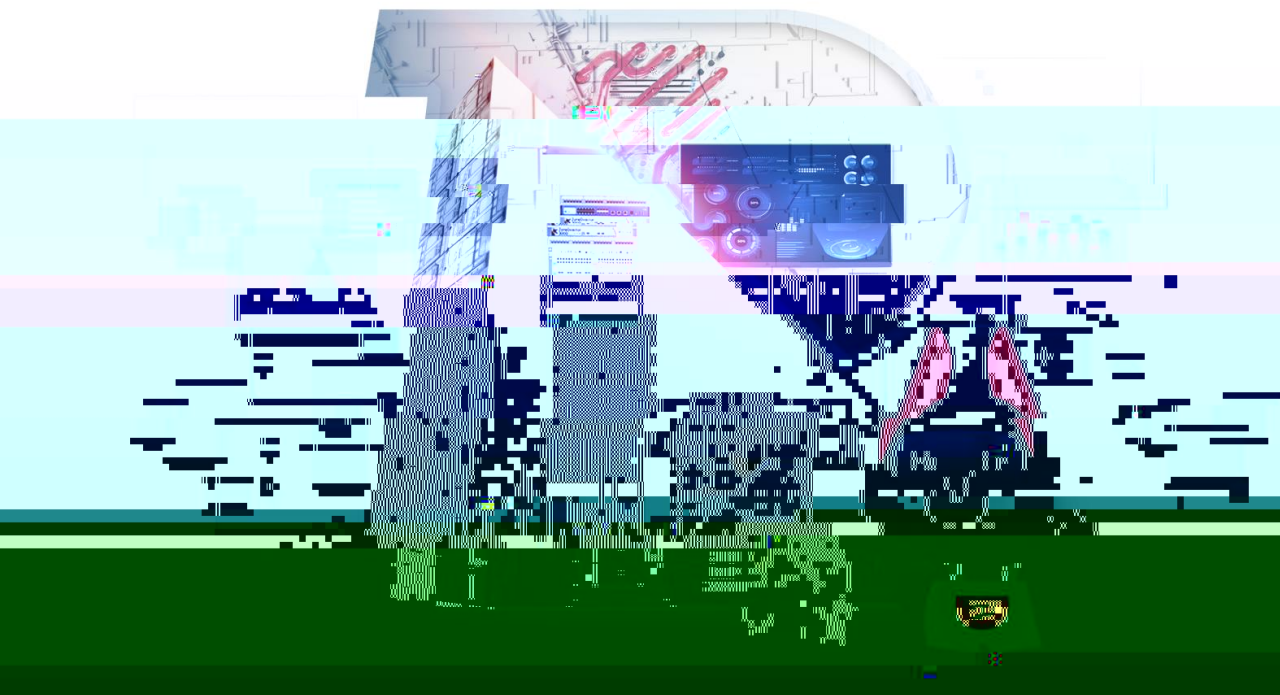



- 1.
- 2.
- 3.
- 4.

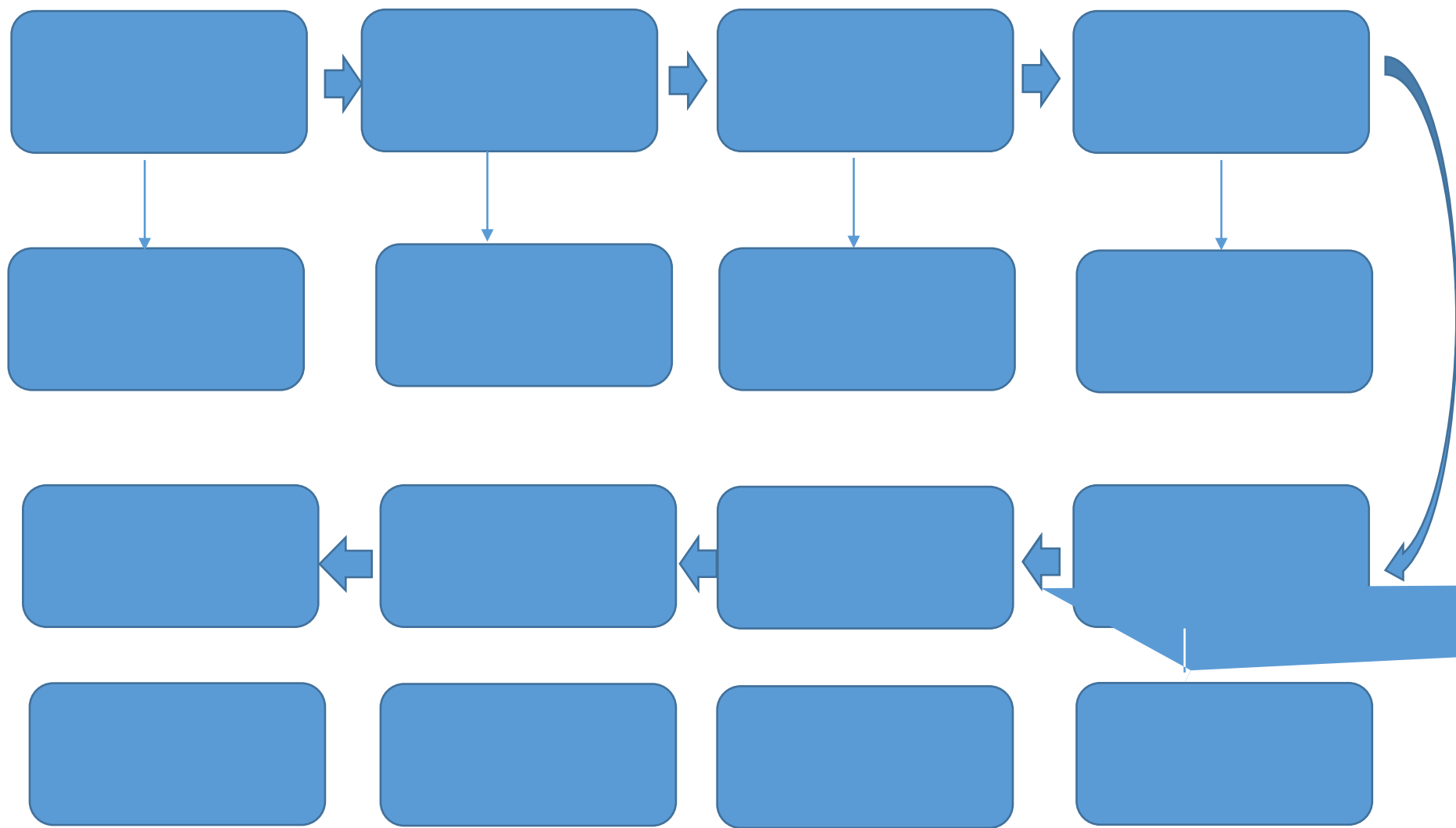



-

G.657 A2

ODTR:

PC

PDA

PC

IxChariot

endPoint



FTP

2.4G 5G

WiFi

WirelessMon

WiFi

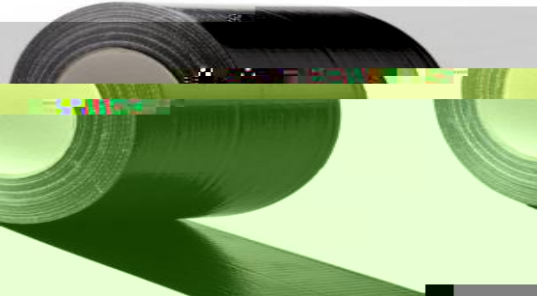
| | | | | | |
|-----|--|----------------|--------|----|---|
| | RVV 2 4 | YD/T 1173-2016 | 12 | 4 | NA |
| | BVVV 2 1 | | AP | 1 | NA |
| |  | | AP | AP | https://item.taobao.com/item.htm?spm=a230r.1.14.15.65d85e7506ueAh&id=623673107776&ns=1&abucket=12#detail |
| |  | | | | AM5552-SF(V2) |
| ODF | | LC | | | NA |
| | | LC | ODF | | |
| | | LC | | AP | |
| | G657.A2 | | AP ODF | AP | |
| |  | | | | NA |



RG-MAP852-SF AP

30cm

RG-MAP852-SF AP



- 1.
- 2.
- 3.
- 4.

RG-AM5552-SF

1U

1

2

2

RG-AM5552-SF

RG-PA150I-F

RG-AM5552-SF

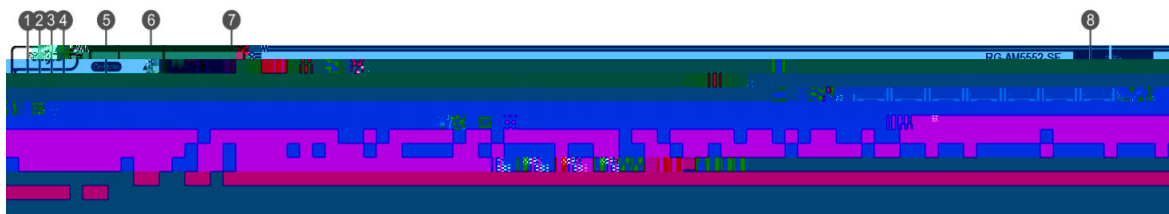

| | | | |
|---|---------|----|----------|
| 1 | | 7 | SFP |
| 2 | (PWR1) | 8 | SFP Plus |
| 3 | (PWR2) | 9 | USB |
| 4 | MGMT | 10 | MiniUSB |
| 5 | Console | 11 | MGMT |
| 6 | SFP | 12 | SFP Plus |

RG-AM5552-SF



RG-AM5552-SF(V2)

1U

PA1000I-P-F

1

2

4 56V

172W

RG-AM5552-SF(V2)

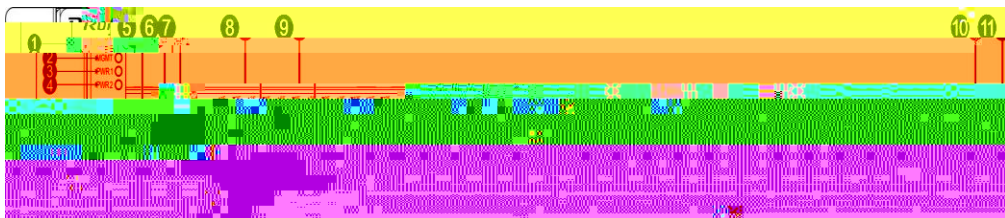

| | | | |
|---|---------|----|----------|
| 1 | | 7 | MGMT |
| 2 | MGMT | 8 | SFP |
| 3 | (PWR1) | 9 | SFP |
| 4 | (PWR2) | 10 | SFP Plus |
| 5 | USB | 11 | SFP Plus |
| 6 | Console | | |

RG-AM5552-SF(V2)

RG-

2

12 AP

200m

RG-AM5552-SF(V2)

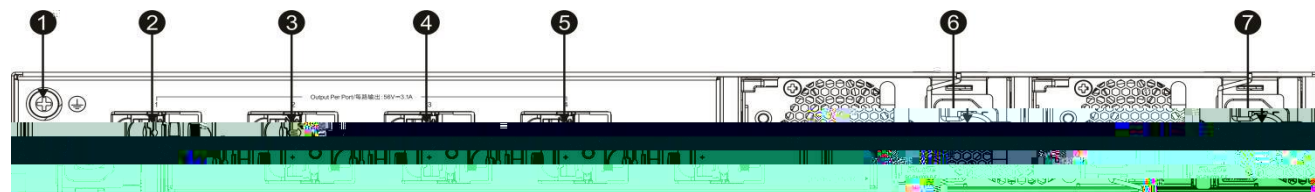

| | |
|------|---|
| 1. | |
| 2-5. | 4 |
| 6 | 2 |
| 7 | 1 |

RG-AM5552-SF(V2)

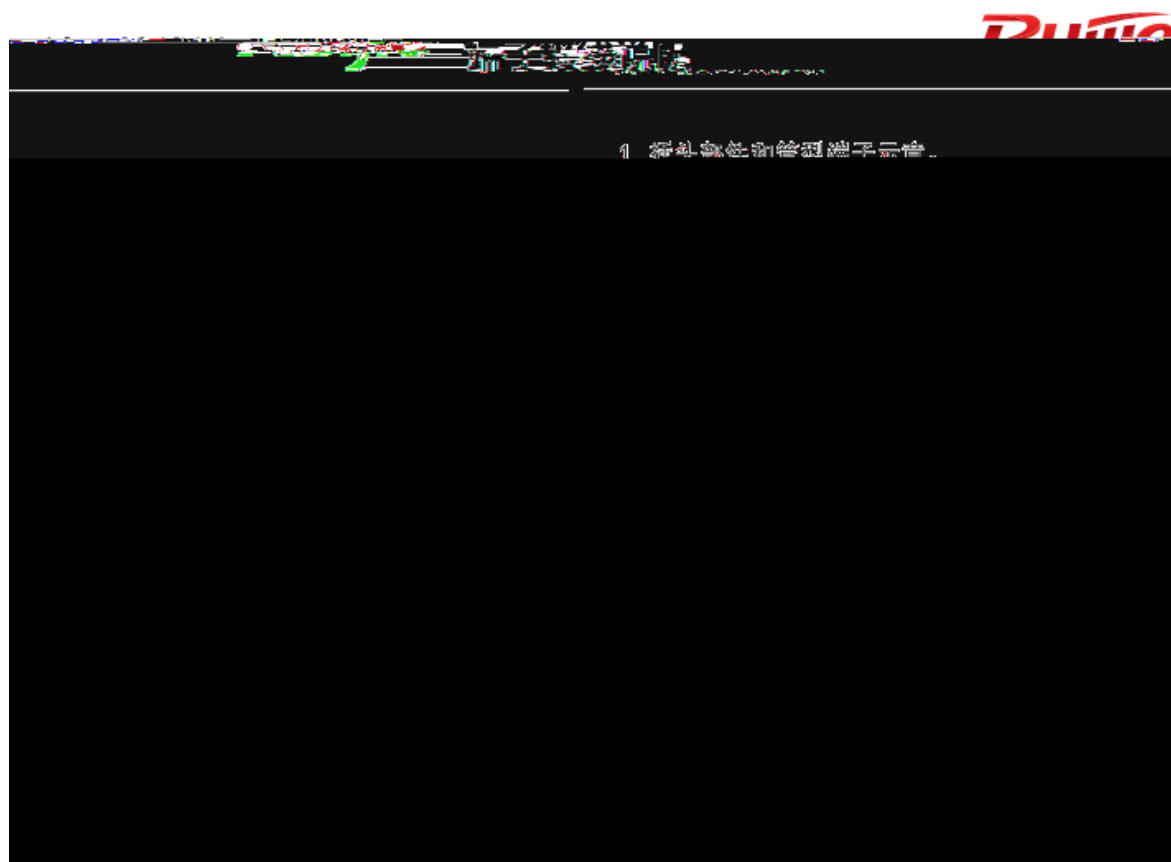

4. 将接线完毕后的4个插头分别插入整机后部的端口内，每个端口最大支持12台微AP。

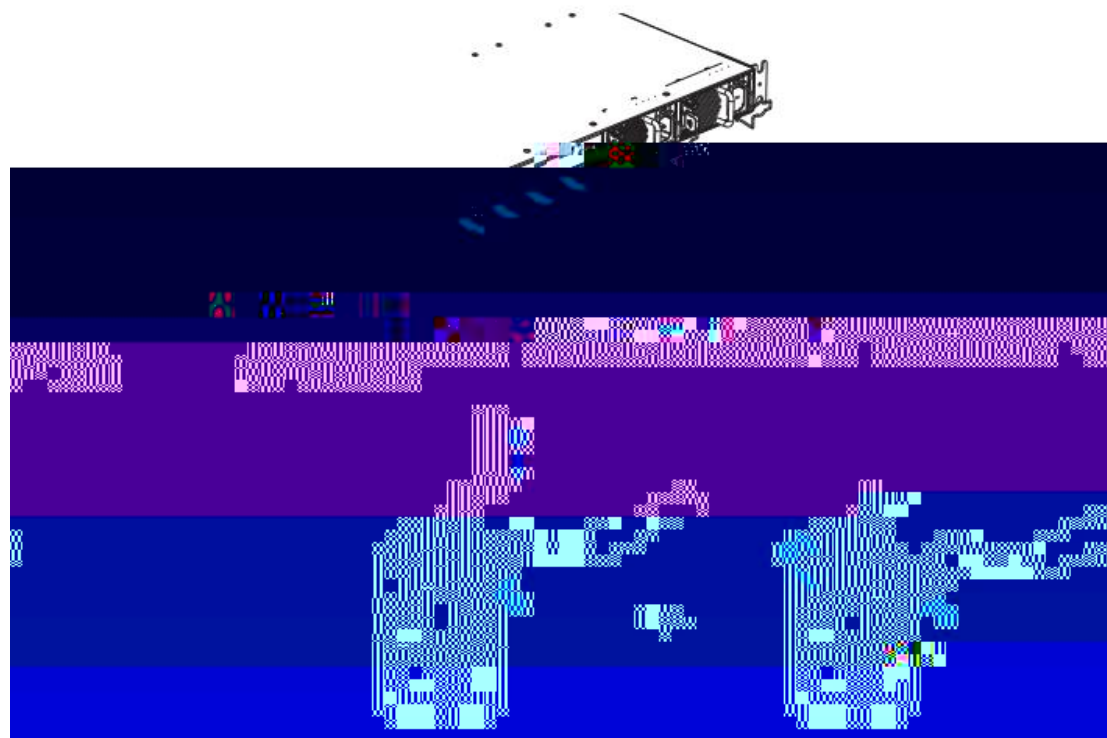



- 1.
- 2.
- 3.
- 4.

48 SFP 4 SFP+ 4 2 2 56V/1000W

12 AP 200

AP

4

AP

1

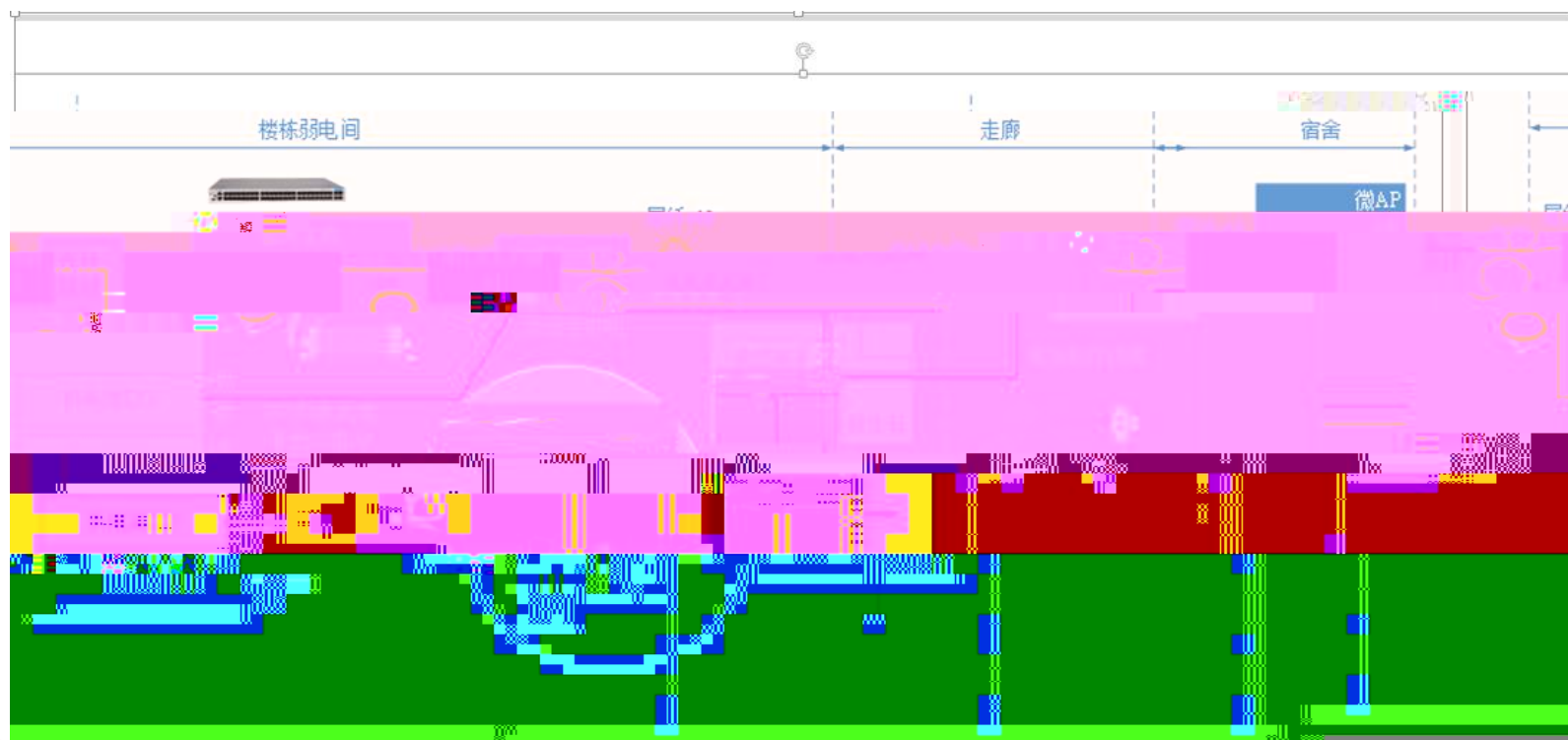

ODF



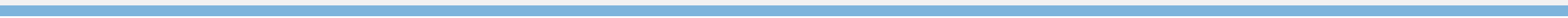

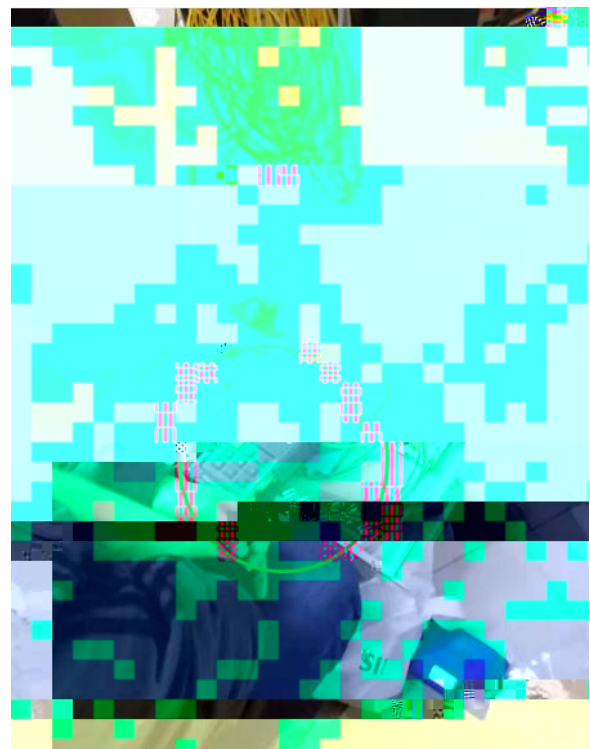

6-8

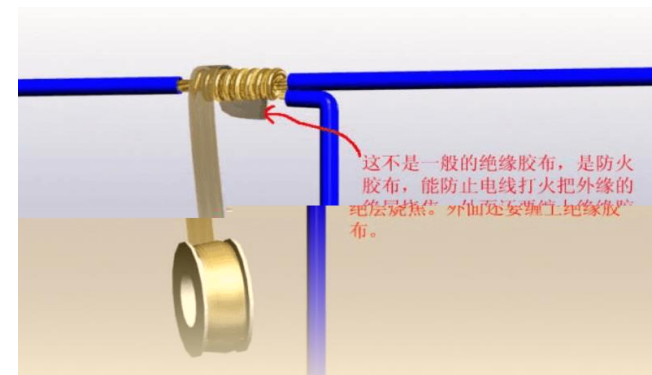
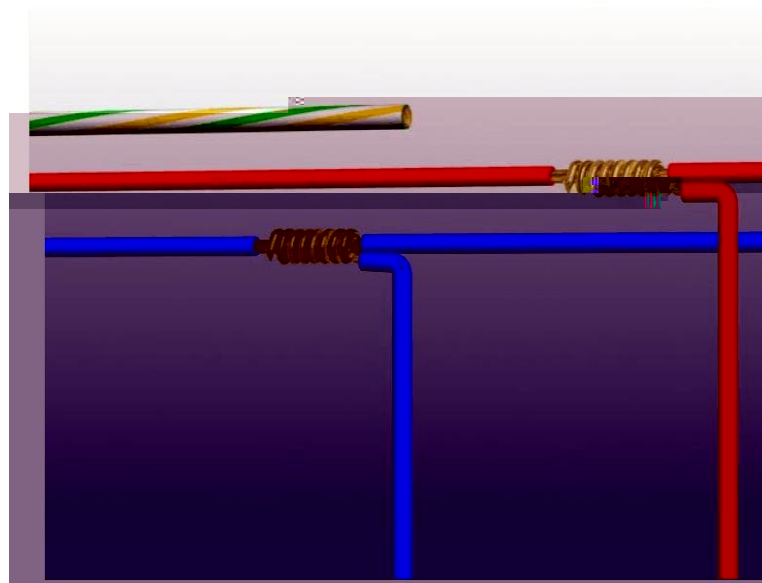
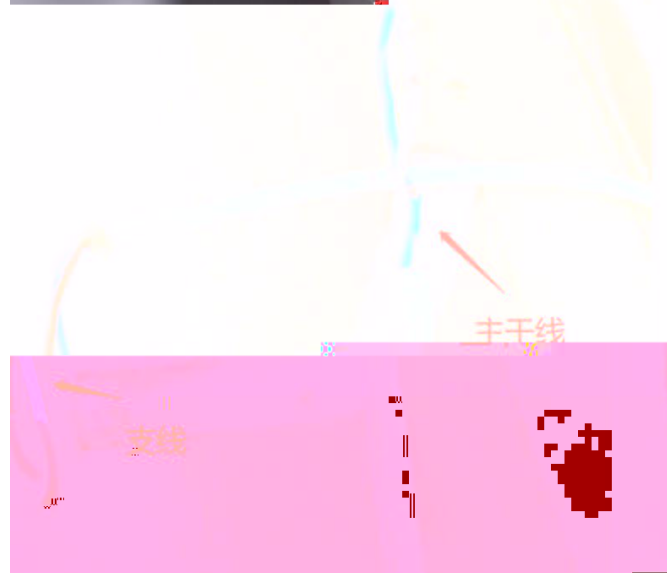
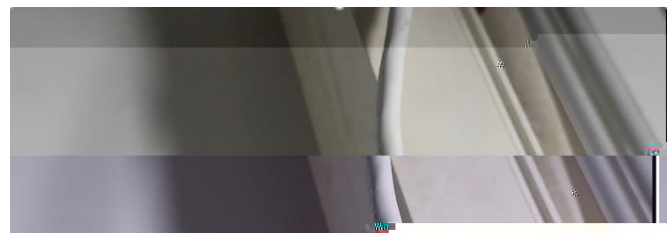

G.657 A2

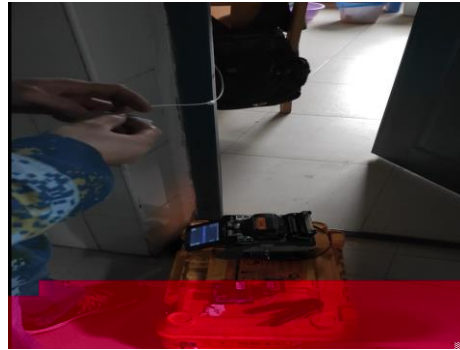

AP

1

AP

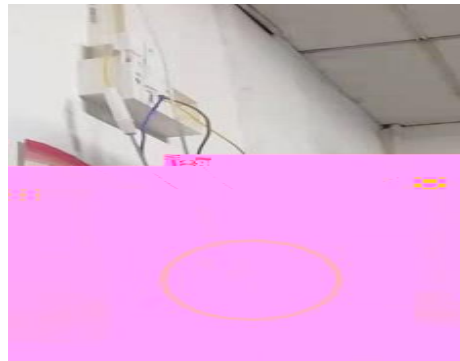

RG-MAP852-SF

86

AP

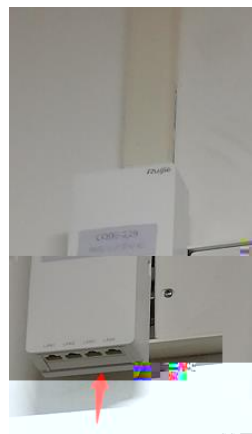
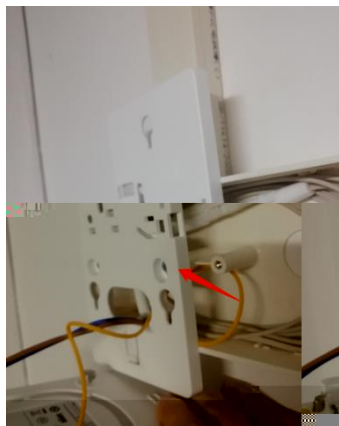

RG-MAP852-SF

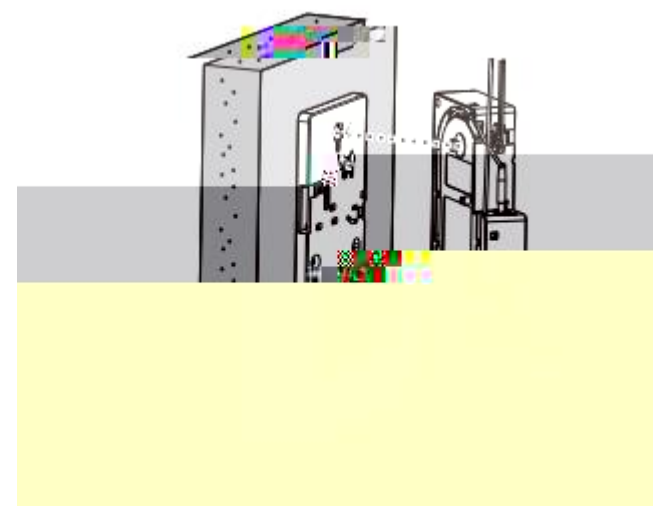
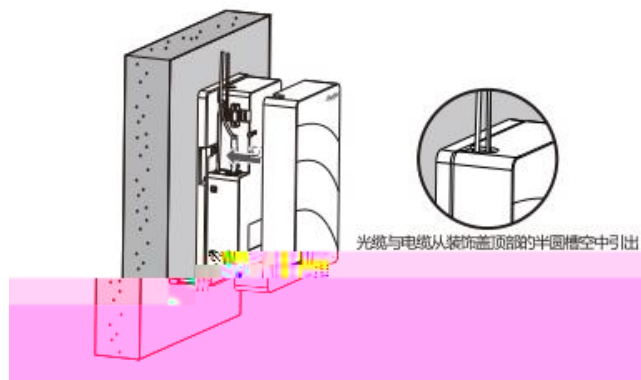
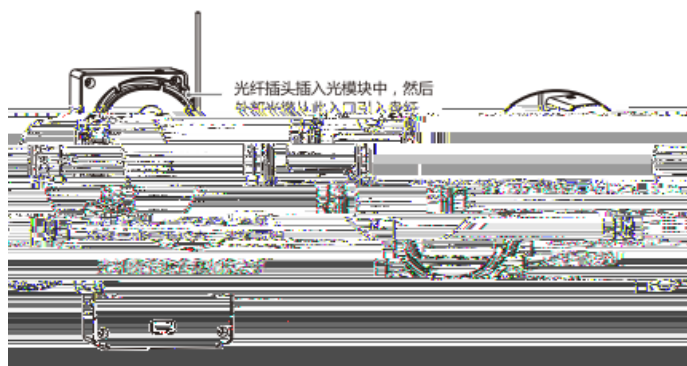



86

AP

AP

AP



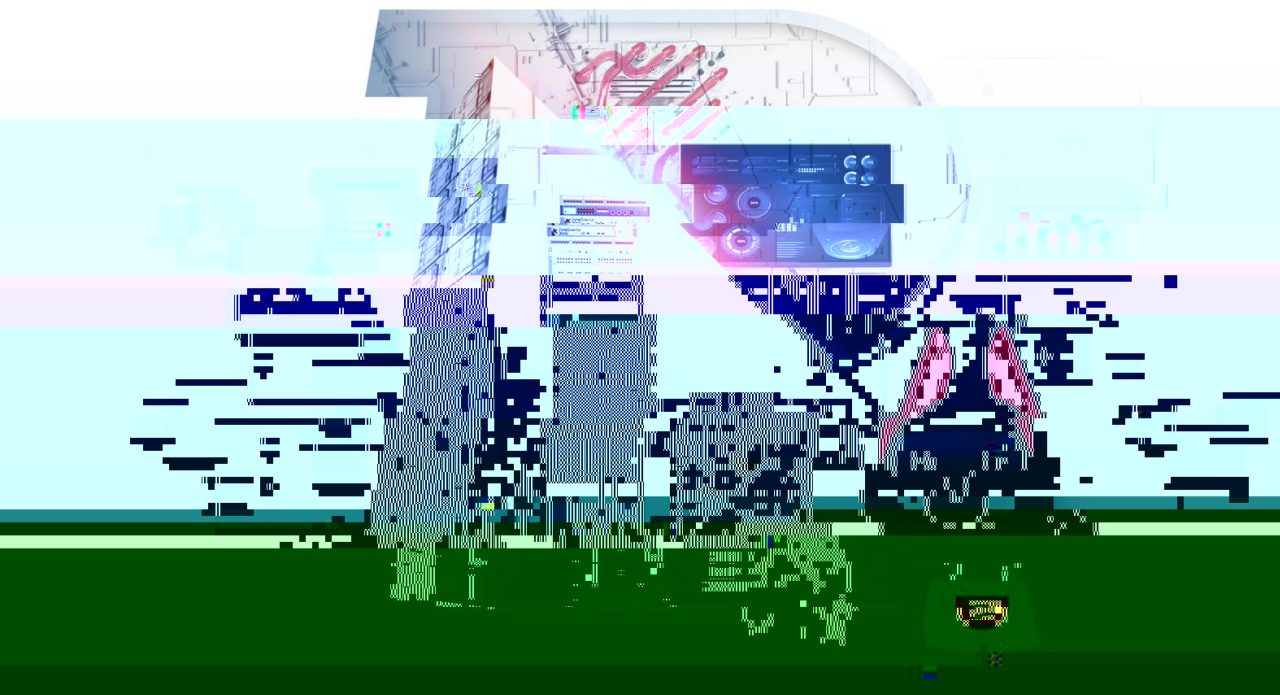

- 1.
- 2.
- 3.
- 4.



```
3
4 /*脚本使用说明: ← 查看脚本使用说明, 填写相关环境参数
5 1. 打开CRT并连接登陆
```

AP

AP

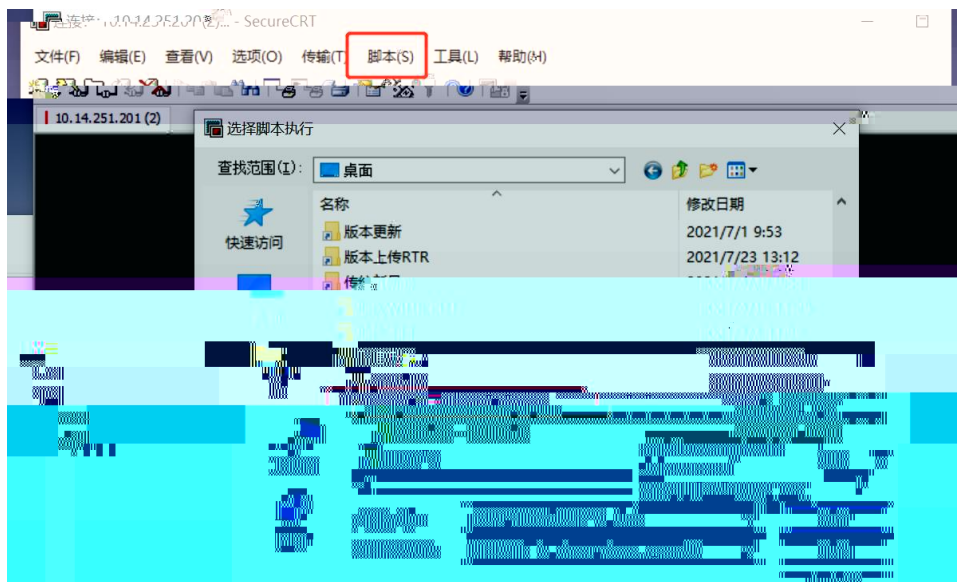

RTR

```
var filePath = 'D:\\'; //必选项：填写结果记录文件的路径—英文路径,如果有子目录的话,必须预先创建好对应的文件目录!!
```



excel

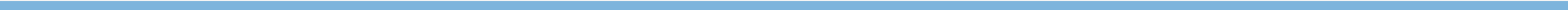

sheet

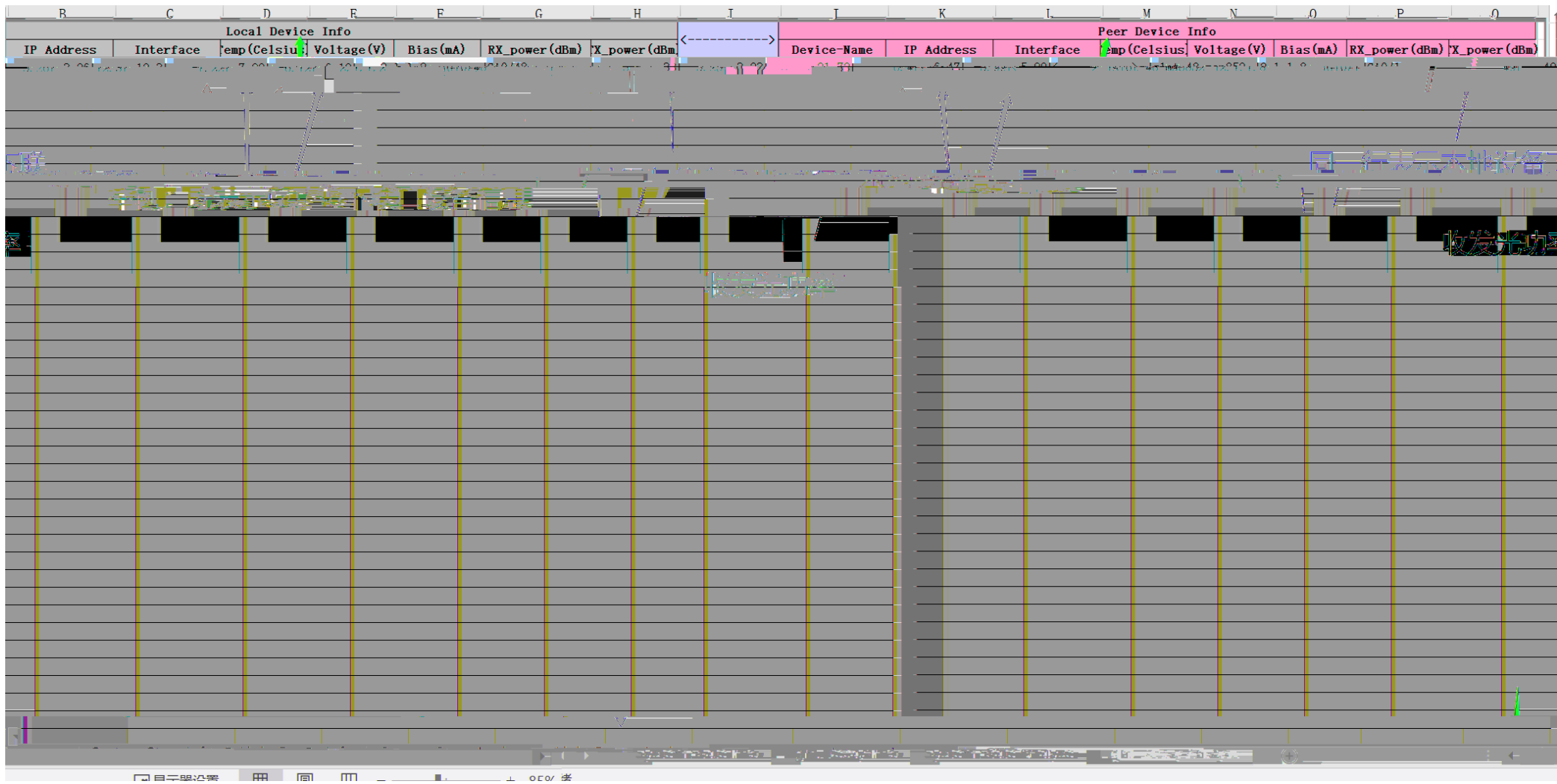



AP

=

+

+ODF

+

3db

-13dbm

-20dbm

1

2

3

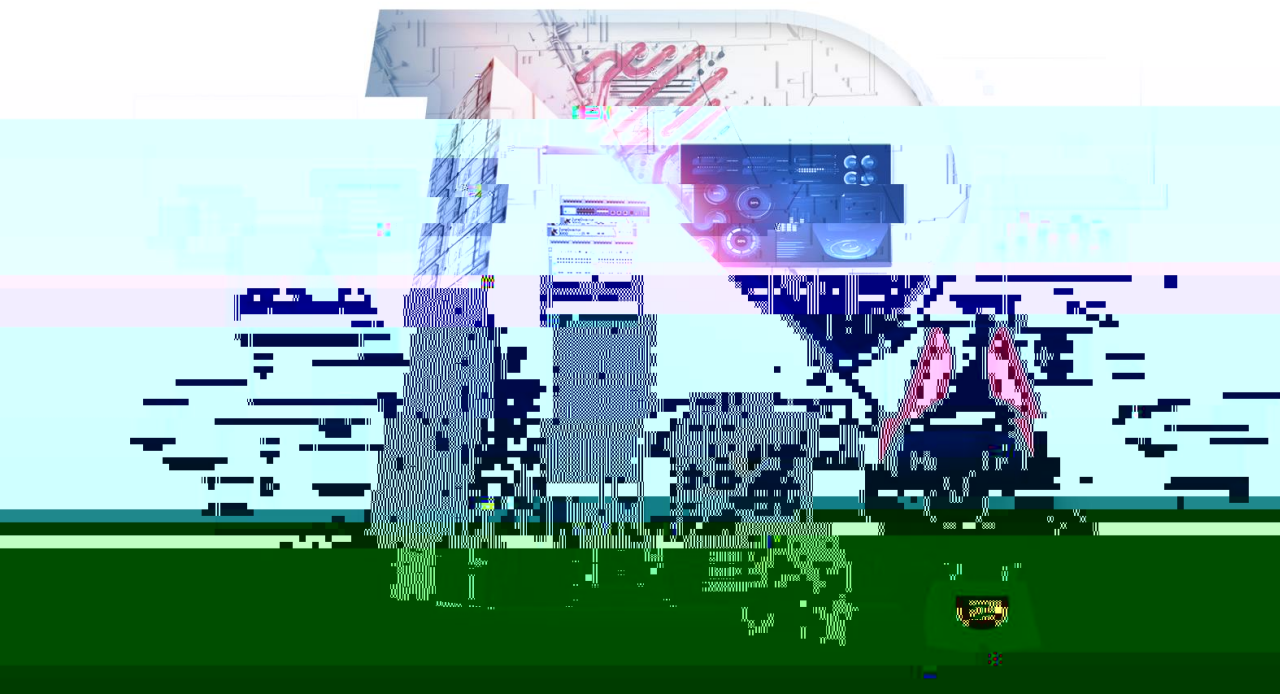

- 1.
- 2.
- 3.
- 4.

1 Link

Link

1

2

3

4

2 RX power

```
am6552-sf-2#  
am6552-sf-2#show int tr d  
-----  
interface GigabitEthernet 0/0/0/0  
-----
```

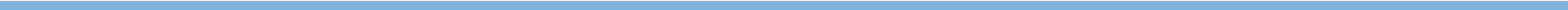



THANKS

29

100036

Office Tel: 010-51715999

Fax: 010-51413399

4008-111-000

www.ruijie.com.cn



A 11

