

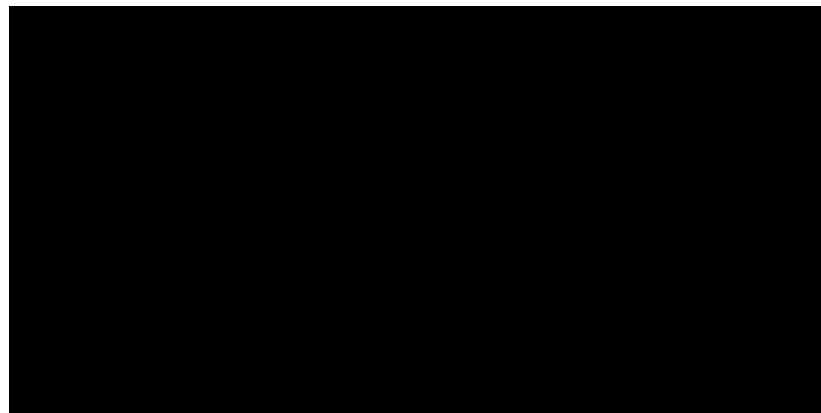

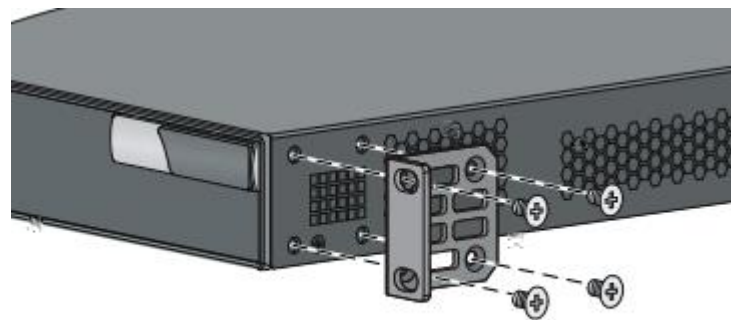

19

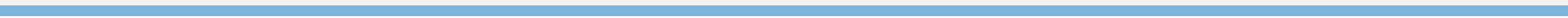







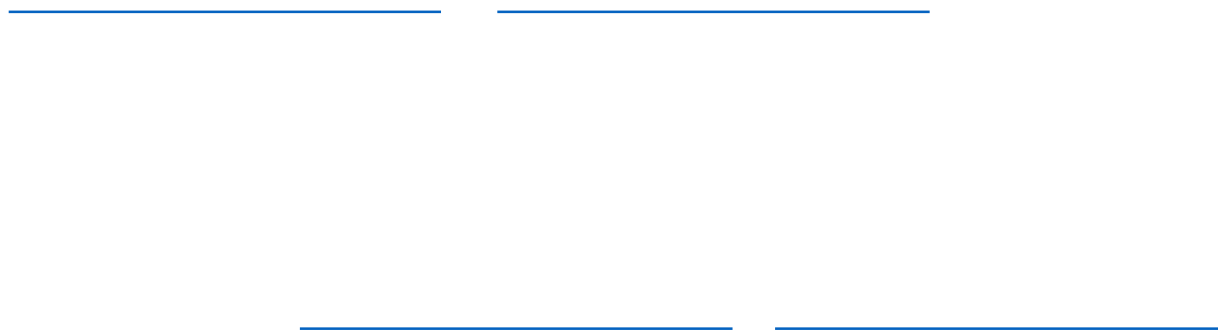



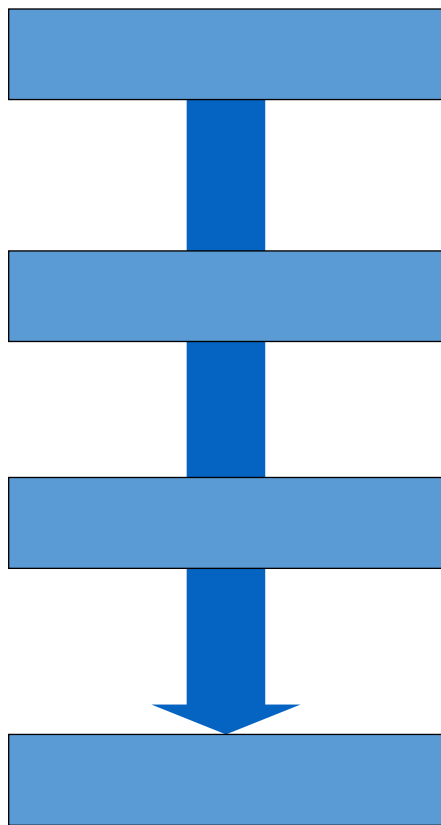

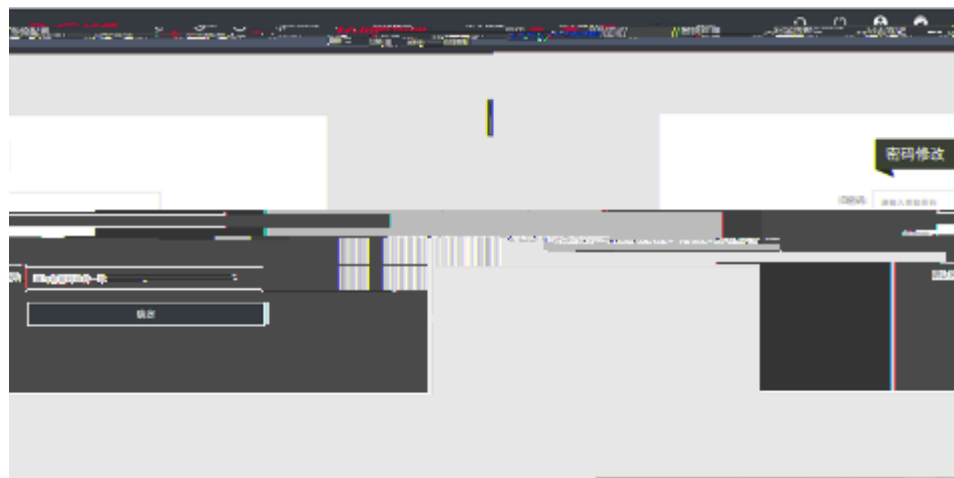
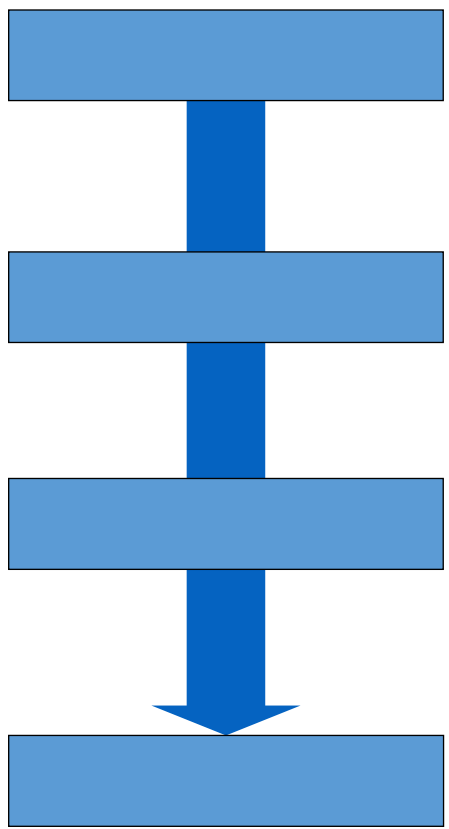

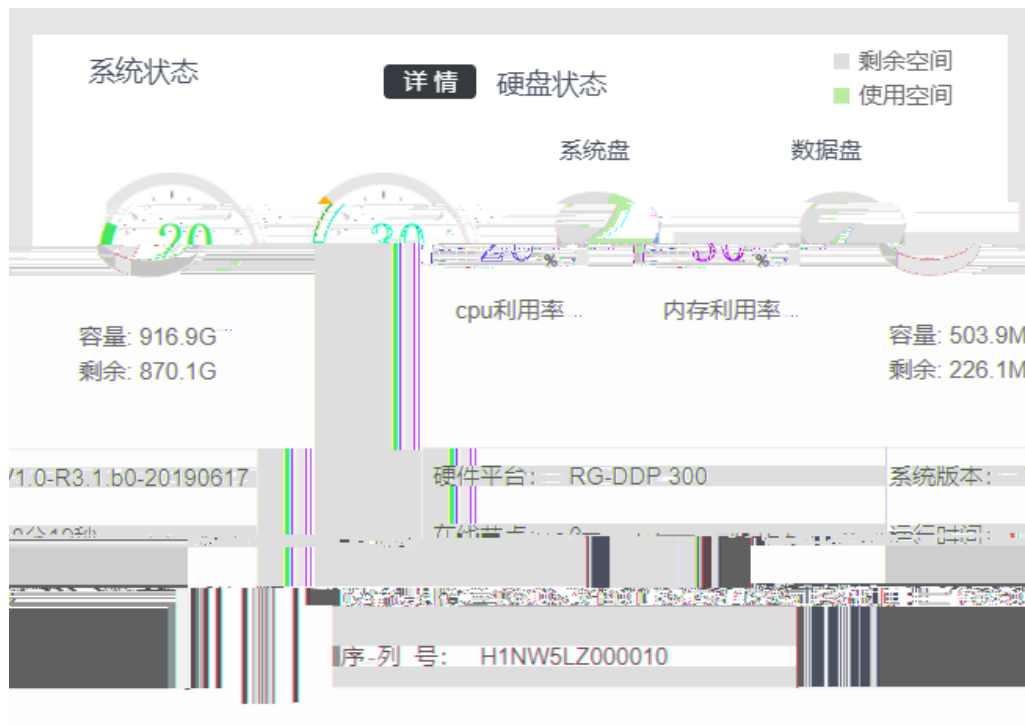
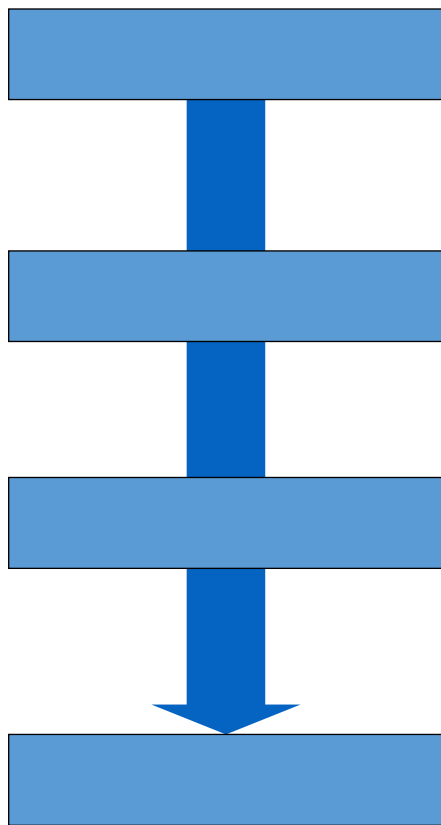

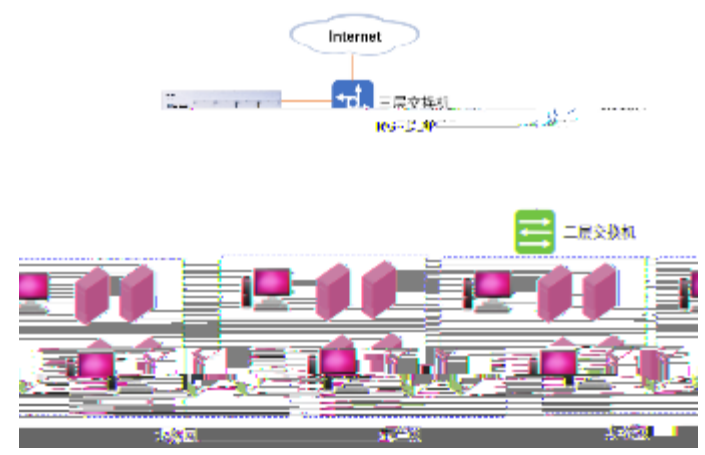





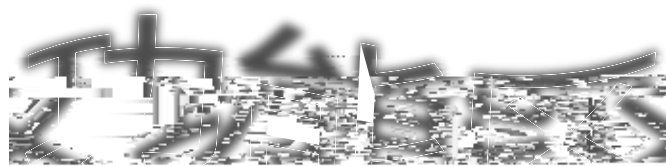
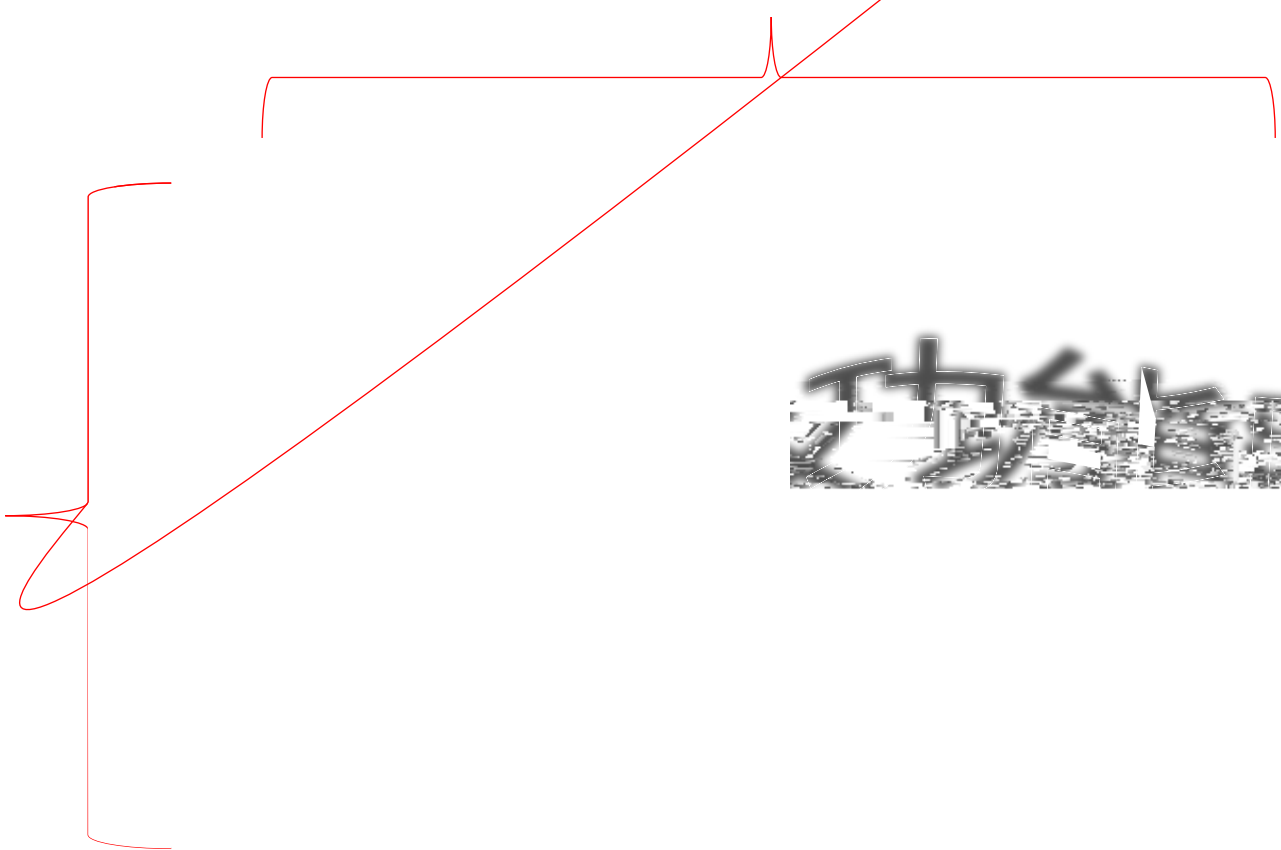





- 微隔离
- 克隆网段
- 特殊应用策略
- 边缘主机
- 主机准入
- 主机感知
- 端口提升

主机感知

