

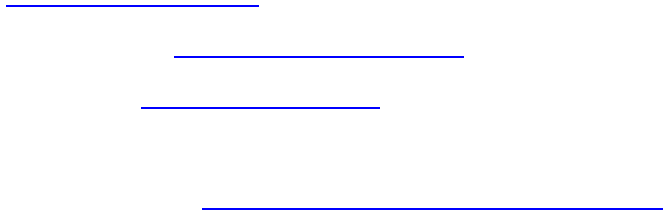

-
-
-
-
-
-
-
-
-
-







| | |
|--|--|
| | |
| | |
| | |
| | |
| | |
| | |
| | |
| | |
| | |
| | |
| | |



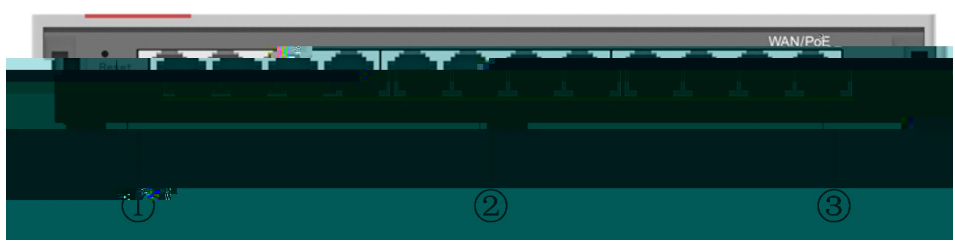
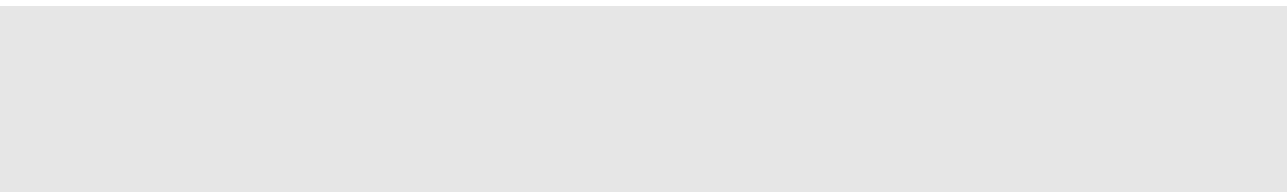
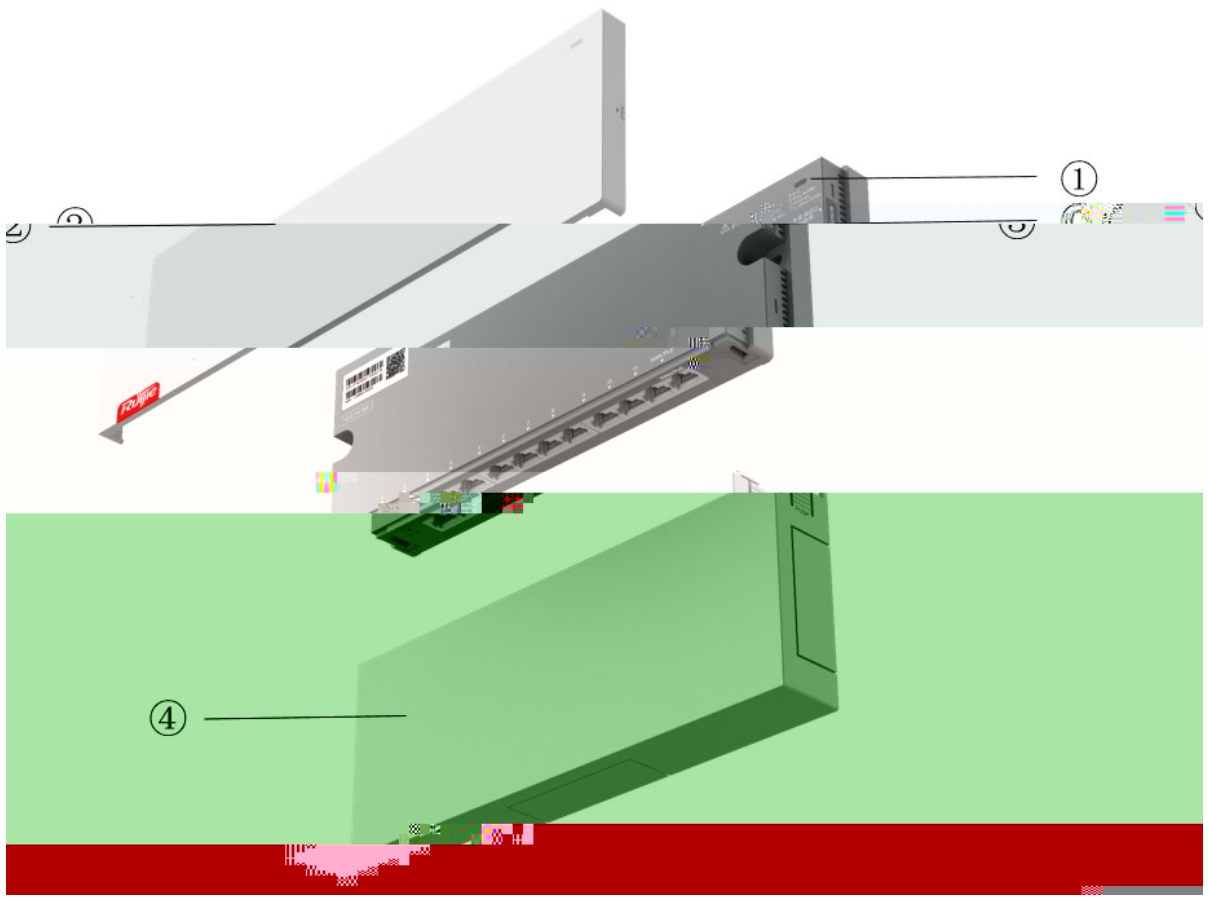



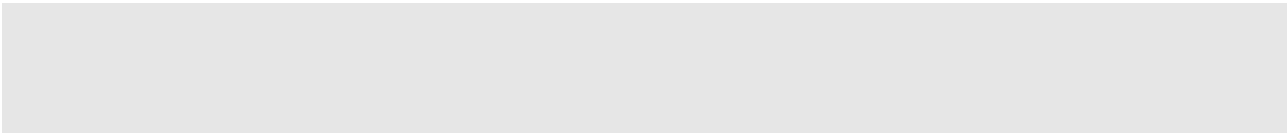
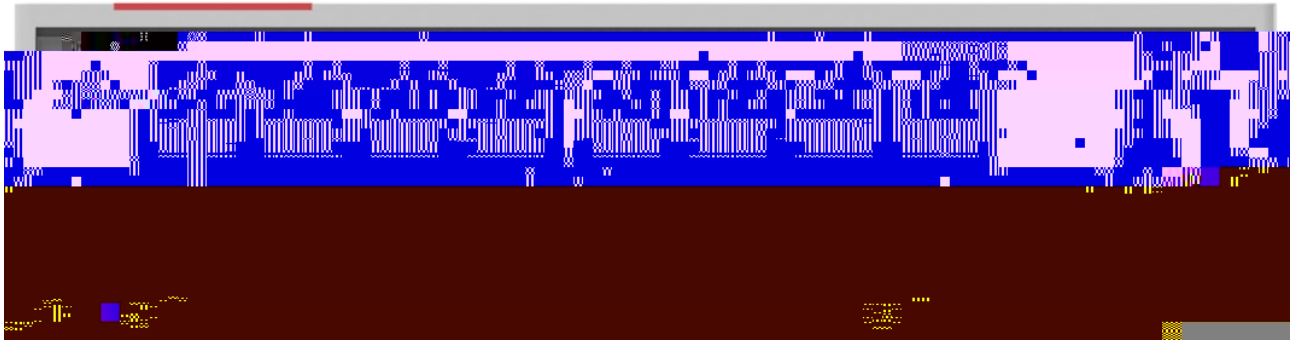
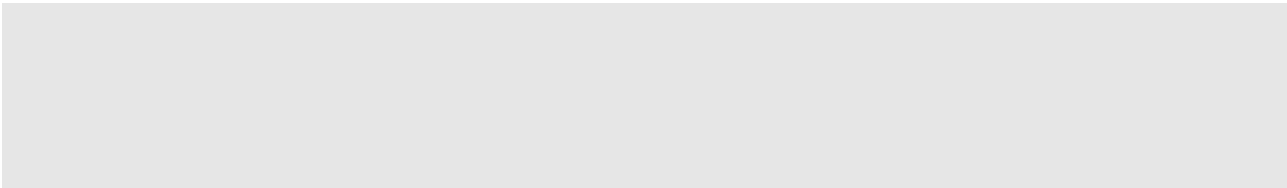

| | |
|--|--|
| | |
| | |
| | |



| | | |
|--|--|--|
| | | |
| | | |



| | |
|--|--|
| | |
| | |
| | |
| | |
| | |









1)





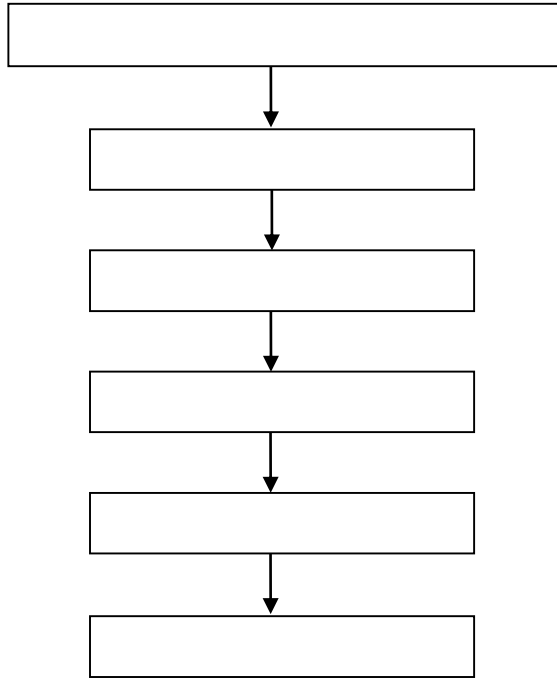

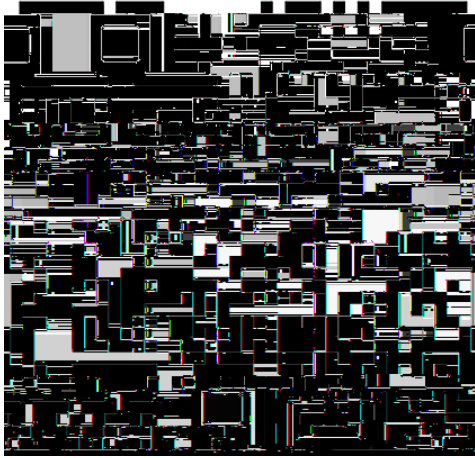

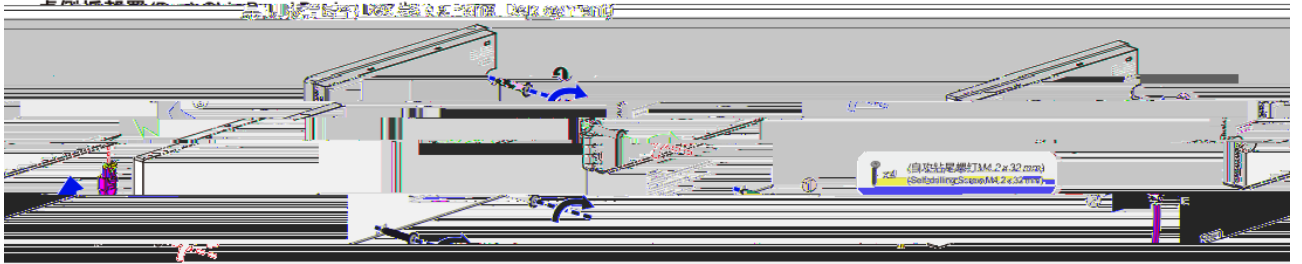

欲插入网线(最右端) (Insert network cable (right end))

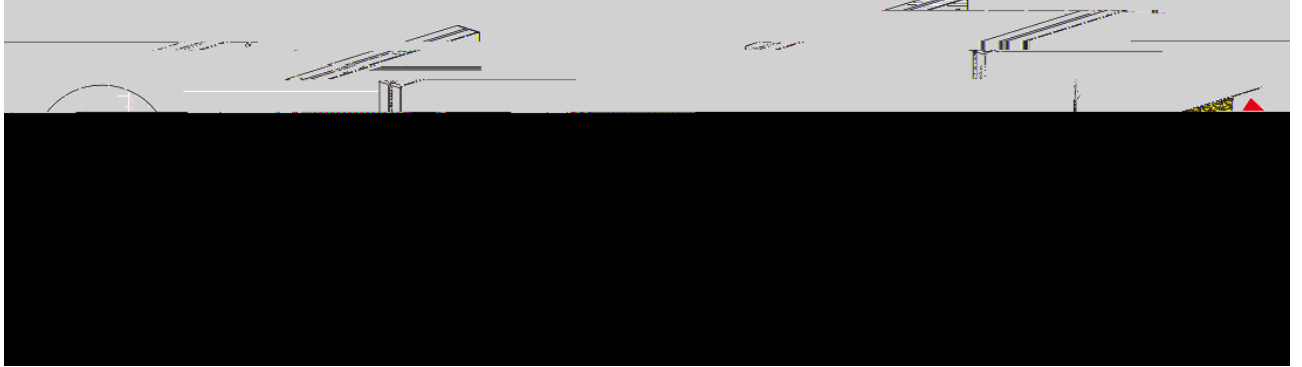



| | | |
|--|--|--|
| | | |
|--|--|--|



| | | |
|--|--|--|
| | | |
| | | |

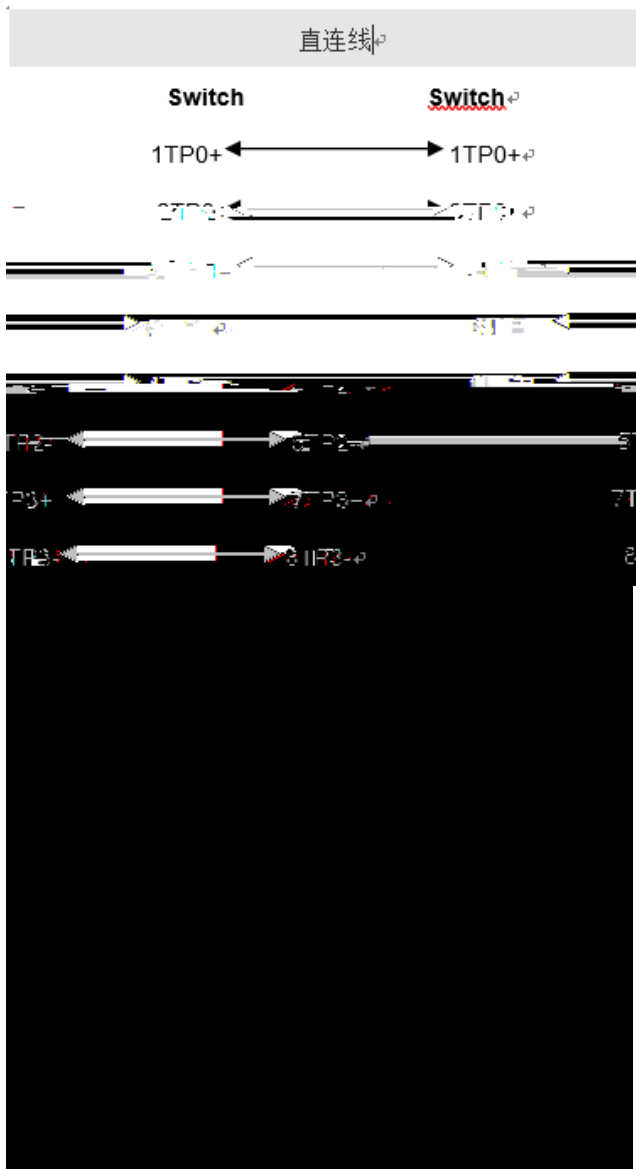

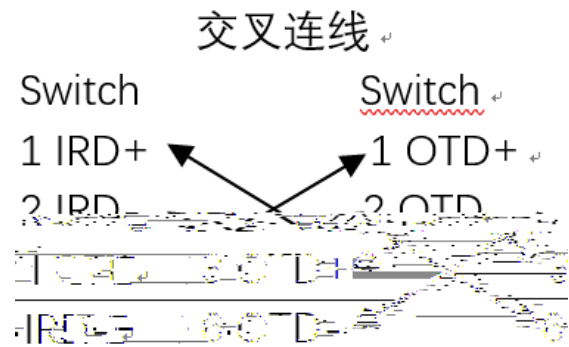
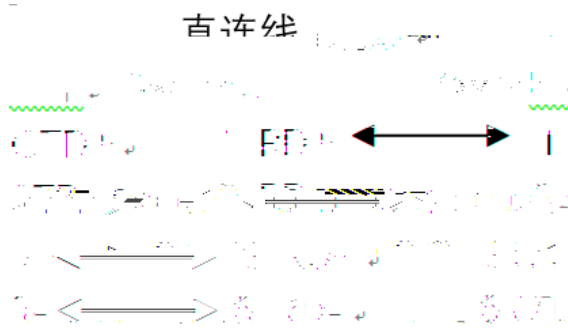

室内连接网线

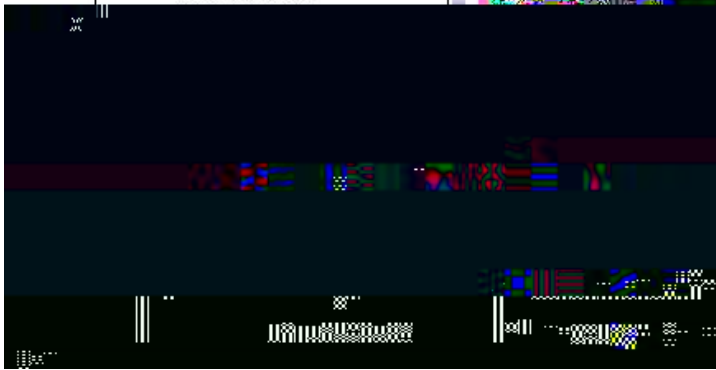

-

-

-

-

-

-

-

-

-
